

GLOFA GM Series



Automation Equipment



Leader in Industrial Electric Power and Automation creating environment-friendly and highly productive industrial society as Total-solution provider

LS Industrial Systems (LSIS), founded in 1974, as a leader in Korean industrial electric power and automation market is trying to be a global leader. LSIS will fulfill its mission providing total-solution as a forerunner of creating environment-friendly and productive industrial future society.



GLOFA GM Series

Programmable Logic Controller



GLOFA GM Series

Programmable Logic Controller

Table of contents



GLOFA-GM7 9	Analog input module (GM4/6) 44
GLOFA-GM7U 11	Analog output module (GM4/6) 45
GLOFA-GM7/GM7U wiring diagram 14	Temperature control module (GM4) 46
GLOFA-GM7/GM7U expansion unit 16	Thermocouple module (GM4/6) 47
Block type PLC configuration 19	RTD module (GM4) 47
GLOFA-GM6 21	PID control module (GM4) 48
GLOFA-GM4 25	Analog timer module (GM4) 48
GLOFA-GM Fast Enet (Ethernet) system 32	Positioning module (APM): (GM4/6) 49
GLOFA-GM Ethernet system configuration 33	I/O interface with external equipment 50
GLOFA-GM Fnet (Fieldbus) system 34	Example of connection with drivers 52
GLOFA-GM Fnet system configuration 35	High speed counter module (GM4/6) 53
GLOFA-GM Cnet (Computer link) system 36	GLOFA-GM program S/W (GMWIN) 54
GLOFA-GM Cnet (Computer link) system configuration 37	PMU 30 series 55
GLOFA-GM Dnet (DeviceNet) system 38	XGT PANEL 56
GLOFA-GM Dnet system configuration 39	Command 57
GLOFA-GM Pnet (Profibus-DP) system 40	Product list 63
GLOFA-GM Pnet system configuration 41	Dimensions 67
SMART I/O 42	Cable connection 69
SMART I/O system configuration 43	



■ GLOFA-GM Series

Series	Specification				Network					
	Max. I/O points (Using remote I/O)	Execution speed (μ s/step)	Memory capacity (byte)		Fast Enet	Fnet	Cnet	Dnet	Pnet	Rnet
			Program	Data						
GM4	GM4-CPUA 2,048 (4,096)	0.2	128K	52K	●	●	●	●	●	●
	GM4-CPUB 2,048 (8,192)	0.2	128K	50K	●	●	●	●	●	●
	GM4-CPUC 3,584 (32,768)	0.12	1M	428K	●	●	●	●	●	●
GM6	384	0.5	68K	32K	●	●	●	●	●	●
GM7	10~80	0.5	68K	32K	●	●	●	●	●	●
GM7U	20~120	0.1	132K	44K				slave	slave	

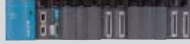
- Enet: Ethernet ● Fnet: Fieldbus ● Cnet: Computer Link ● Dnet: DeviceNet ● Pnet: Profibus-DP
- Rnet: Dedicated communication for LSIS SMART I/O

Series	Special modules						
	Analog I/O	High speed control	Position control	PID control	Thermocouple input	RTD	Analog timer
GM4 	7 Types G4F-AD3A (8Ch) G4F-AD2A (4Ch) G4F-DA3V (8Ch) G4F-DA2V (4Ch) G4F-DA3I (8Ch) G4F-DA2I (4Ch) G4F-DA1A (2Ch)	3 Types G4F-HSCA (1Ch) G4F-HO1A (2Ch) G4F-HD1A (2Ch)	6 Types G4F-PPXO G4F-PPXD } *1 (Axis X=1, 2, 3)	2 Types G4F-PIDB (16 loops) G4F-TMCA (2 loops)	1 Type G4F-TC2A (4Ch)	1 Type G4F-RD2A (4Ch)	1 Type G4F-AT3A (8 points)
GM6 	3 Types G6F-AD2A (4Ch) G6F-DA2V (4Ch) G6F-DA2I (4Ch)	4 Types G6F-HSCA (1Ch) G6F-HO1A (2Ch) G6F-HD1A (2Ch) Built-in (CPUC)	6 Types G6F-PPXO G6F-PPXD } *1 (Axis X=1, 2, 3)	Built-in (CPUB/CPUC)	1 Type G6F-TC2A (4Ch)	-	-
GM7 *2 	3 Types	Built-in (1Ch)	Built-in (Pulse output)	Built-in	-	-	1 Type G7F-AT2A (4 points)
GM7U *2 	7 Types	Built-in (4Ch)	Built-in Control axis: 2	Built-in	-	1 Type	1 Type G7F-AT2A (4 points)

- *1) -HO1A, -PPXO: Open collector type,
-HD1A, -PPXD: Line drive type
- *2) Refer to P19

■ Part number name

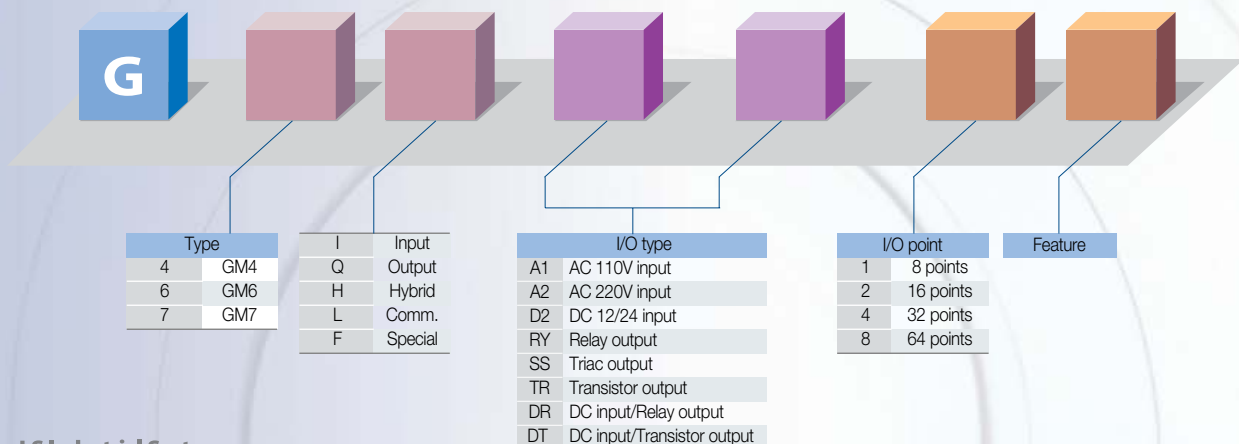

IEC61131-3 Language

/ Open Network System

ISO9001

Number: E124950

Powerful and compact PLC

CPU, digital I/O and power part are embedded in block-type PLCs, which is easy to install in whatever area you want for system configuration. In case of module-type PLCs, system configuration is easily achieved by a variety of modules (CPUs, I/O, special modules, network modules).



GM7/GM7U



Global standard (IEC61131-3) language

- IL (Instruction list)
- LD (Ladder diagram)
- SFC (Sequential function chart)

Dedicated CPU (one-chip) for high speed processing time

- GM4 (0.2 μ s/step)
- GM4C (0.12 μ s/step)
- GM6 (0.5 μ s/step)
- GM7 (0.5 μ s/step)
- GM7U (0.1 μ s/step)

Convenient programming tool

- Windows 95/98/ME/NT/2000/XP based
- Editing, Monitoring, Debugging function by symbol
- Supports IL, LD, SFC language
- Simulation without PLC

GLOFA GM

Programmable
Logic ●●●
Controller

Series

LS GLOFA GM Series

GM4

GM6

GM7



GM6



GM4

International standard communication protocol suitable for CIM.

- Enet Modules (Ethernet, 10/100Mbps)
- Fnet Modules (Fieldbus, 1Mbps)
- Dnet Modules (DeviceNet, 125k, 250k, 500kbps)
- Pnet Modules (Profibus-DP, 9.6kbps~12Mbps)

Various special function module

- Analog I/O modules
- High speed counter modules
- Position control modules
- RTD, Thermocouple input modules
- PID, Analog timer module

International standard Ethernet (GM4/6)

- Fast Ethernet (10/100Mbps)
- 100BASE-T, 10BASE-5, support
- IEEE802.3 & Protocol (TCP/IP, UDP/IP)
- Communication with other PLC Systems using function block (FB)
- Two types: open Ethernet, dedicated Ethernet

■ General specifications

Item	Description	Standard			
Ambient temperature	0~55°C (32 ~131°F)				
Storage temperature	-25~70°C (-13~158°F)				
Ambient humidity	5~95%RH (Non-condensing)				
Storage humidity	5~95%RH (Non-condensing)				
Vibration	Occasional vibration		10 times each direction (X, Y and Z)	IEC 61131-2	
	Frequency	Acceleration			Pulse width
	10 ≤ f < 57 Hz	-			0.075mm
	57 ≤ f ≤ 150 Hz	9.8% _s (1G)			-
	Continuous vibration				
	Frequency	Acceleration			Pulse width
10 ≤ f < 57 Hz	-	0.035mm			
57 ≤ f < 150 Hz	4.9% _s (0.5G)	-			
Shocks	<ul style="list-style-type: none"> • Peak acceleration: 147%_s(15G) • Duration: 11ms • Half-sine, 3 times each direction per each axis 				
Impulse noise	Square wave impulse noise	± 1,500Vp-p		LSIS Standard	
	Electrostatic discharge	± 4kV		IEC 61131-2/IEC 1000-4-2	
	Radiated electromagnetic field noise	27~500MHz, 10V/m		IEC 61131-2/IEC 1000-4-3	
	Fast transient/burst noise	Power supply	Digital I/O (more than 24V)	Digital I/O (>24V) Analog I/O, Comm.I/O	IEC 61131-2/IEC 1000-4-4
	2kV	1kV	0.25kV		
Operation ambience	Free from corrosive gases and excessive dust				
Altitude	Up to 2,000m (6,562ft)				
Pollution degree	Less than or equal to 2*				
Cooling method	Air-cooling				

* Pollution degree 2 is nonconductive pollution of the sort where occasionally a temporary conductivity caused by condensation must be expected.

■ Technical specifications

Item	GM4-CPUA/B	GM4-CPUC	GM6	GM7	GM7U	
Control method	Cyclic execution of stored program, Interrupt task execution					
I/O Updating method	Program refresh per 1 scan					
Program languages	IL (Instruction list) / LD (Ladder diagram) / SFC (Sequential function chart)					
Number of Instructions	Operator	IL: 20, LD: 13				
	Standard function	194	194 + 'real number F'	194		
	Special function block	Special function blocks for special modules				
Configuration speed	Operator	0.2μs/step	0.12μs/step	0.5μs/step	0.1μs/step	
	Standard function/Standard function block	0.2μs/step	0.12μs/step	0.5μs/step		
Program capacity	128K *	1M	68K		132K	
I/O points	Using 32pt module	1,024	1,792	384	10~80	20~120
	Using 64pt module	2,048	3,584	-	-	-
	Network	4,096 / 8,192	32,768	-	-	-
Direct variable area	2~16K	8~117K		2~8K	10K	
Symbolic variable area *	52K/50K	428K		32K	30K	
Timer *	Not limited, Time range: 0.001~4294967.295 sec (1,193hours)					
Counter *	Not limited, Count range: -32,768~32,767					
Operation mode	RUN, STOP, PAUSE, DEBUG					
Data retention at power failure	Set "retain" at data declaration					
Program type	Scan	180		100		
	Task	Time driven	8	32	8	
		External	8			
		Internal	16		8	
		HSC	-			4
		Error	-	_ERR_SYS	-	
Initialization	_INIT, _H_INIT		_INIT			
Self-diagnosis	Execution, Delay, Memory error, I/O error, Battery error, Power supply error					
Restart mode	Cold, Warm, Hot restart			Cold, Warm restart		

* K: kilobyte

* One timer occupies 20 bytes in symbolic variable area

* Symbolic variable area: Maximum symbolic area - Direct variable area

* One counter occupies 8 bytes in symbolic variable area

Number of communication module installation



GLOFA GM Series
Programmable Logic Controller

■ GM4/6

Item	GM4-CPUA	GM4-CPUB	GM4-CPUC	GM6-CPUA/B/C
No. of total communication modules	4	4	8	4
Cnet only	4	4	8	4
High-speed link modules	2	4	8	2
Cnet + HSL link modules	2 + 2	2 + 2	8 in total	2 + 2

Item	Cnet I/F module	HSL module	Installation in expansion base
GM4-CPUA	4	2	×
GM4-CPUB	4	4	○
GM4-CPUC	8	8	○

Network support in GM4/6

- Master (High-speed link): Fnet, Rnet, DeviceNet, Fast Ethernet, Profibus-DP
- Cnet: RS-232C, RS-422/485
- MODBUS (ASCII/RTU) as slave inserting MODBUS library into Cnet module

■ GM7/GM7U

Item	GM7U	GM7 (10 point)	GM7 (20 to 60 point)
No. of total communication modules	2 (built-in Cnet included)	1	1
Cnet only	2 Built-in RS-485 is included.	1 Built-in RS-232C/485 Simultaneous use is not allowed.	1 Built-in RS-232C or Cnet I/F module. Simultaneous use is not allowed.
High-speed link modules	1	Option unit is not allowed	Only 1
Cnet + HS link modules	1 + 1 (built-in RS-485 + HSL 1)		

Network support in GM7/GM7U

- Master (High-speed link): Fnet*¹, Rnet*²
- Slave (High-speed link): Profibus-DP*³, DeviceNet*³
- Cnet: RS-232C, RS-422/485
- MODBUS (ASCII/RTU) as master/slave in parameter setting (GMWIN)

*1) LS dedicated protocol for Fnet I/F modules

*2) LS dedicated protocol for SMART I/Os

*3) Slave only

GLOFA-GM7

Programmable Logic Controller

■ Features

- High function and high performance with dedicated MPU chip
 - IEC 61131-3
- GLOFA-GM Network
 - Fnet, Rnet as master module
 - DeviceNet, Profibus-DP as slave module
- Various built-in functions
 - High speed counter 1 point (1-phase 16kHz, 2-phase 8kHz)
 - Pulse output 1 point (2kHz only available in Tr-output module)
 - PID loop with autotuning
 - Pulse catch 8 points (pulse catch: Min. 0.2ms)
 - Input filter (Noise reduction)
- External interrupt point: 8 points
(Task program execution by external interrupt input)
- RS-232C interface 1 channel (Built-in Cnet):
dedicated, User-defined, Modbus protocol



■ Specifications

Item		Specifications	Remark	
Operation method		Cyclic execution of stored program, Time-driven operation, Internal task operation		
I/O control method		Scan synchronized batch processing method (Refresh method)	Immediate input/output is available by 'Direct I/O' function	
Program language		IL (Instruction list) / LD (ladder diagram) / SFC (Sequential function chart)		
Number of Instructions	Operator	LD: 13, IL: 20		
	Standard function	194		
	Standard function block	12		
	Special function block	Each special module has its own special function block		
Processing speed	Operator	0.5 μ s / instruction		
	Standard function/function block	0.5 μ s / step		
Programming memory capacity		68K	Built-in flash memory (128K)	
I/O points		From 10 to 80 points (according to modules)		
Data Memory	Direct variable area (DVA)	2~8K	Setting in GMWIN	
	Symbolic variable area (SVA)	32K - Direct variable area		
Timer		No limitation. Time range: 0.001~4294967.295 sec (1193 hours)	20 bytes per 1 timer in SVA	
Counter		No limitation. Count range: -32768~32767	8 bytes per 1 counter in SVA	
Operation mode		RUN, STOP, PAUSE, DEBUG		
Data retention at power failure		Set to 'Retain' at data declaration		
Number of program blocks		100		
Program type	Task	Scan	100 - (Number of program blocks in task)	
		Time-driven	8	
		External	8	
		Internal	8	
		Initialization	1 (_INIT)	
Self-diagnostic function		Watchdog timer, Memory error, I/O error, etc		
Restart mode		Cold, Warm		
Built-in function	PID control	Control by function block, Autotuning, Forward/Reverse operation, Manual output, Operation scan time setting		
		Cnet interface	Dedicated, Modbus, User-defined protocol	
	HSC	Counting speed	1-phase 16kHz, 2-phase 8kHz	
		Counting method	1-phase up/down counter (up/down: selection by program)	
			1-phase up/down counter (up/down: selection by B-phase) 2-phase up/down counter (up/down: Automatic selection by phase difference)	
		Multiplication	1, 2 or 4	
	Task program running	Task program running when the current value of HSC reaches the setting value		
	Pulse catch	Min. pulse width: 2ms, Maximum 8 points available to use		
	Pulse output	2kHz, 1Ch		
	External interrupt Input	8 points		
Input filter function	0~15ms (Setting by 1ms)			

* 1) Built-in RS-232C signal: 4 (Rx), 7 (Tx), 5 (SG)

* G7M-DR10A, G7M-DR10A (/DC), G7M-DT10A: RS-232C and RS-485 port are embedded.
(Simultaneous use is not allowed) and a communication option module is not available.

GLOFA-GM7

Programmable Logic Controller

Input/output specifications

Input part

Item	Type	Main					Expansion
		G7M-DR10A (/DC) G7M-DT10A	G7M-DR20A (/DC) G7M-DT20A	G7M-DR30A (/DC) G7M-DT30A	G7M-DR40A (/DC) G7M-DT40A	G7M-DR60A (/DC) G7M-DT60A	G7E-DR10A
Power supply for main module		G7M-DR□□A, G7M-DT□□A: AC100~240V (50/60Hz), G7M-DR□□A/DC: DC24V					
Input point		6	12	18	24	36	6
Insulation method		Photocoupler					
Rated input voltage		DC24V					
Rated input current		7mA (%Ix0.0.0~%Ix0.0.2: 16mA)					
Operation voltage range		DC20.4V~28.8V (Ripple rate < 5%)					
Max. simultaneous input		100% Simultaneous ON					
On voltage/current		DC19V or higher/5.7mA or higher (%Ix0.0.0~%Ix0.0.2: 12.7mA or higher)					
Off voltage/current		DC6V or lower/1.8mA or lower (%Ix0.0.0~%Ix0.0.2: 4mA or lower)					
Input impedance		3.3kΩ					
Response time	Off → On	15ms or less*					
	On → Off	15ms or less*					
Operating indicator		LED					

* It is available to set from 1ms to 15ms in parameter of GMWIN (unit: ms)

Relay output part

Item	Type	Main					Expansion
		G7M-DR10A (/DC)	G7M-DR20A (/DC)	G7M-DR30A (/DC)	G7M-DR40A (/DC)	G7M-DR60A (/DC)	G7E-DR10A
Output point		4	8	12	16	24	4
Insulation method		Relay insulation					
Rated load voltage/current		DC24V/2A (Resistive load), AC220V/2A (COS φ =1)/point, 5A/COM					
Min. load voltage/current		DC5V/1mA					
Max. load voltage		AC250V, DC110V					
Off leakage current		0.1mA or less (AC220V, 60Hz)					
Max. on/off frequency		1,200 times/hr					
Surge absorber		-					
Service life	Mechanical	20million times or more					
	Electrical	100,000 times or more (Rated voltage/current load) AC200V/1.5A, AC240V/1A (COS φ =0.7) 100,000 times or more AC200V/1A, AC240V/0.5A (COS φ =0.35) 100,000 times or more DC24V/1A, DC100V/0.1A (L/R=7ms) 100,000 times or more					
Response time	Off → On	10ms or less					
	On → Off	12ms or less					
Operating indicator		LED					

Transistor output part

Item	Type	Main				
		G7M-DT10A	G7M-DT20A	G7M-DT30A	G7M-DT40A	G7M-DT60A
Output point		4	8	12	16	24
Insulation method		Photocoupler				
Rated load voltage		DC12/24V				
Operating load voltage		DC10.2~26.4V				
Rated load current		0.5A/point, 3A/COM				
Off leakage current		0.1mA or less				
On voltage drop		1.5V or less (Max.load)				
Surge absorber		Clamp diode				
Common		4 points/COM	8 points/COM	8 points/COM	8 points/COM (×2)	8 points/COM (×3)
		Sink type	Sink type	4 points/COM Sink type	Sink type	Sink type
Response time	Off → On	2ms or less				
	On → Off	2ms or less				
Operating indicator		LED				

GLOFA-GM7U

Programmable Logic Controller



■ Features

Powerful built-in functions

- High-speed counter: 32-bit signed operation,
 - Counter range: -2,147,483,648 ~ 2,147,483,647
 - Function: ring counter, latch counter, comparison (equal /zone/task), RPM
- Positioning function (DRT/DT type)
 - Control axis: 2 axes (100kHz)
 - Operation method: single, repeat
 - Operation mode: end, keep, continuous
 - Additional functions: return to origin, JOG operation, PWM output
- PID operation function
 - Relay/PRC auto-tuning, SV ramp, delta MV, PWM output, position/velocity algorithm, Forward/Reverse

Various expansion modules

- 7 Digital I/O modules: G7E-DR(08/10/20)A, G7E-TR10A, G7E-DC08A, G7E-RY(08/16)A
- 9 Analog I/O modules: G7F-ADHA(B/C), G7F-AD2A(B), G7F-DA2I(V), G7F-AT2A, G7F-RD2A
- 6 Comm. modules: G7L-CUEB(C), G7L-DBEA, G7L-PBEA, G7L-FUEA, G7L-RUEA
- 2 Option modules: G7E-RTCA, G7M-M256B

■ Specifications

Item	Specifications				Remark	
	20	30	40	60		
Output type	DR type: Relay output					
	DRT type: NPN Tr output + Relay output					
	DT (N) type: NPN Tr output					
	DT (P) type: PNP Tr output					
Operation method	Cyclic execution of stored program, Time-driven operation, Internal task operation					
I/O control method	Scan synchronized batch processing method (Refresh method)					
Program language	IL (Instruction list) / LD (ladder diagram) / SFC (Sequential function chart)					
Number of Instructions	Operator	LD: 13, IL: 20				
	Standard function	194				
	Standard function block	12				
	Special function block	Function blocks for built-in functions, special, communication modules				
Processing speed for operator	0.1~0.9 μ s/step					
Program memory capacity	132 Kbyte (including parameters)					
I/O points	Input: 12, Output: 8	Input: 18, Output: 12	Input: 24, Output: 16	Input: 36, Output: 24	Max. 120	
Data	Direct variable area (DVA)	14K				
Memory	Symbolic variable area (SVA)	30K				
Timer	No limitation. Time range: 0.001~4294967.295 sec (1193 hours)					
Counter	No limitation. Count range: -32768~32767					
Operation mode	RUN, STOP, PAUSE, DEBUG					
Data retention at power failure	Set to 'Retain' at data declaration					
Number of program blocks	100					
Program type	Scan	100 - (Number of program blocks in task)			8 in total	
	Task	Time-driven	8			
		External	8			
		Internal	8			
		HSC	4			
		Initialization	1 (_INIT)			
Self-diagnostic function	Watchdog timer, Memory error, I/O error, etc					
Restart mode	Cold, Warm					
Built-in function	PID control	Control by function block, Autotuning, Forward/Reverse operation, Manual output, Delta MV, SV ramp function, Anti-windup, etc			DRT/DT type only	
	Cnet interface	Dedicated, LS Inverter, MODBUS, User-defined, No protocol				
	HSC	Counting speed	1-phase: 100kHz (2channels) / 20kHz (2channels) 2-phase: 50kHz (1channel) / 10kHz (1channel)			
		Counting method	1-phase up counter			
			1-phase up/down counter (up/down: selection by B-phase) 2-phase up/down counter (up/down: pulse input) 2-phase up/down counter (up/down: automatic selection by phase difference)			
	Additional	Internal/external preset, Latch counter, Comparison output, RPM				
	Position	Basic	No. of control axis: 2, Control method: PTP/speed/synchronous, Control unit: pulse Positioning data: 20/axis (operation step no. 1~20)			
		Positioning	Position method: absolute/incremental, Operation method: single/repeat Address range: -2,147,483,648~2,147,483,647 Speed: Max. 100kpps (setting range: 5~100,000pps) Acceleration/Deceleration method: Trapezoidal method			
			Return to origin JOG	DOG/HOME (ON), DOG/HOME (OFF), approximate origin Setting range: 5~100,000 (high/low speed)		
	Pulse catch	Minimum pulse width: 10 μ s (2 points), 50 μ s (2 points)				
	External interrupt	10 μ s (2 points), 50 μ s (2 points)				
Input filter	0, 1, 2, 5, 10, 20, 50, 100, 200, 500, 1000ms (Default: 10ms)					

GLOFA-GM7U

Programmable Logic Controller

Input/output specifications

Input part

Type		Main			
		G7M-DR20U (/DC)	G7M-DR30U (/DC)	G7M-DR40U (/DC)	G7M-DR60U (/DC)
Item		G7M-DT20U (N) (/DC)	G7M-DT30U (N) (/DC)	G7M-DT40U (N) (/DC)	G7M-DT60U (N) (/DC)
		G7M-DT20U (P) (/DC)	G7M-DT30U (P) (/DC)	G7M-DT40U (P) (/DC)	G7M-DT60U (P) (/DC)
		G7M-DRT20U (/DC)	G7M-DRT30U (/DC)	G7M-DRT40U (/DC)	G7M-DRT60U (/DC)
Power supply		G7M-DR□□□□U, G7M-DT□□□□U, G7M-DRT□□□□U: AC100~240V (50/60Hz), G7M-DR□□□□U/DC, G7M-DT□□□□U/DC, G7M-DRT□□□□U/DC: DC12/24V			
Input point		12	18	24	36
Insulation method		Photocoupler			
Rated input voltage		DC24V			
Rated input current		7mA (%x0.0.0~%x0.0.3 [9mA])			
Operating voltage range		DC20.4V~28.8V (Ripple rate <5%)			
Max. simultaneous input		100% simultaneous ON			
On voltage/current		DC19V or higher/5.7mA or higher			
Off voltage/current		DC6V or lower/1.8mA or lower			
Input impedance		About 3.3kΩ (%x0.0.0~%x0.0.3 [2.7kΩ])			
Response time	Off → On	0, 1, 2, 5, 10, 20, 50, 100, 200, 500, 1000ms (Default: 10ms)			
	On → Off	0, 1, 2, 5, 10, 20, 50, 100, 200, 500, 1000ms (Default: 10ms)			
Operating indicator		LED			

Relay output part

Type		Main			
		G7M-DR20U (/DC)	G7M-DR30U (/DC)	G7M-DR40U (/DC)	G7M-DR60U (/DC)
Output point		8	12	16	24
Insulation method		Relay insulation			
Rated load voltage/current		DC24V/2A (Resistive load), AC220V/2A (COS φ =1)/point, 5A/COM			
Min. load voltage/current		DC5V/1mA			
Max. load voltage		AC250V, DC110V			
Off leakage current		0.1mA or less (AC220V, 60Hz)			
Max. on/off frequency		1200 times/hr			
Surge absorber		None			
Service life	Mechanical	20 million times or more			
	Electrical	100,000 times or more (rated load voltage)			
Response time	Off → On	10ms or less			
	On → Off	12ms or less			
Operating indicator		LED			

Transistor/mixed output part

Type		Main			
		G7M-DT20U (N)*1 (/DC)	G7M-DT30U (N) (/DC)	G7M-DT40U (N) (/DC)	G7M-DT60U (N) (/DC)
Item		G7M-DT20U (P)*2 (/DC)	G7M-DT30U (P) (/DC)	G7M-DT40U (P) (/DC)	G7M-DT60U (P) (/DC)
		G7M-DRT20U (/DC)	G7M-DRT30U (/DC)	G7M-DRT40U (/DC)	G7M-DRT60U (/DC)
Output point	DT-type output point	8	12	16	24
	DRT-type Tr. output point	4	4	4	4
	DRT-type relay output point	4	8	12	20
Insulation method		Photocoupler (Tr. output points), Relay insulation (Relay output points)			
Rated load voltage		DC12V/24V			
Operation load voltage		DC10.2~26.4V			
Max. load voltage		0.5A/point (DRT type: %Qx0.0.0~%Qx0.0.3 (0.1A/point), DT type: %Qx0.0.0~%Qx0.0.1 (0.1A/point))			
Off leakage current		0.1mA or less			
Voltage drop		Less than DC0.3V			
Surge absorber		Zener diode			
Inrush current		Less than 4A, 10ms			
Response time	Off → On	0.2ms or less (Tr)			
	On → Off	0.2ms or less (Tr)			
Operating indicator		LED			

*1) (N) stands for NPN Tr.

*2) (P) stands for PNP Tr.

* For the characteristics of relay outputs in a DRT-type module, please refer to the output part (relay) in the above.

Expansion specifications

■ Input part

Item	Type	Expansion			
		G7E-DC08A *	G7E-DR08A *	G7E-DR10A	G7E-DR20A
Input point		8	4	6	12
Insulation method		Photocoupler			
Rated input voltage		DC24V			
Rated input current		7mA			
Operating voltage range		DC20.4V~28.8V (Ripple rate <5%)			
Max. simultaneous input		100% simultaneous ON			
On voltage/current		DC19V or higher/5.7mA or higher			
Off voltage/current		DC6V or lower/1.8mA or lower			
Input impedance		About 3.3k Ω			
Response time	Off \rightarrow On	0, 1, 2, 5, 10, 20, 50, 100, 200, 500, 1000ms (Default: 10ms)			
	On \rightarrow Off	0, 1, 2, 5, 10, 20, 50, 100, 200, 500, 1000ms (Default: 10ms)			
Operating indicator		LED			

■ Relay output part

Item	Type	Expansion				
		G7E-RY08A *	G7E-RY16A	G7E-DR08A *	G7E-DR10A	G7E-DR20A
Output point		8	16	4	4	8
Insulation method		Relay insulation				
Rated load voltage/current		DC24V/2A (Resistive load), AC220V/2A (COS ϕ =1)/point, 5A/COM				
Min. load voltage/current		DC5V/1mA				
Max. load voltage		AC250V, DC110V				
Off leakage current		0.1mA or less (AC220V, 60Hz)				
Max. on/off frequency		1200 times/hr				
Surge absorber		None				
Service life	Mechanical	20 million times or more				
	Electrical	100,000 times or more (rated load voltage)				
Response time	Off \rightarrow On	10ms or less				
	On \rightarrow Off	12ms or less				
Operating indicator		LED				

■ Transistor output

Item	Type	Expansion
		G7E-TR10A
Output point		10
Insulation method		Photocoupler
Rated load voltage		DC12/24V
Operation load voltage		DC10.2~26.4V
Max. load voltage		0.5A/points, 4A/COM
Off leakage current		0.1mA or less
Inrush current		Less than 4A, 10ms
Voltage drop		Less than DC1.5V
Surge absorber		Clamp diode
Response time	Off \rightarrow On	2ms or lower
	On \rightarrow Off	2ms or lower
Operating indicator		LED

* Slim type

GLOFA-GM7/GM7U wiring diagram

Programmable Logic Controller

Wiring diagram

■ Input/Output (Relay output) & Input/Output (Expansion)

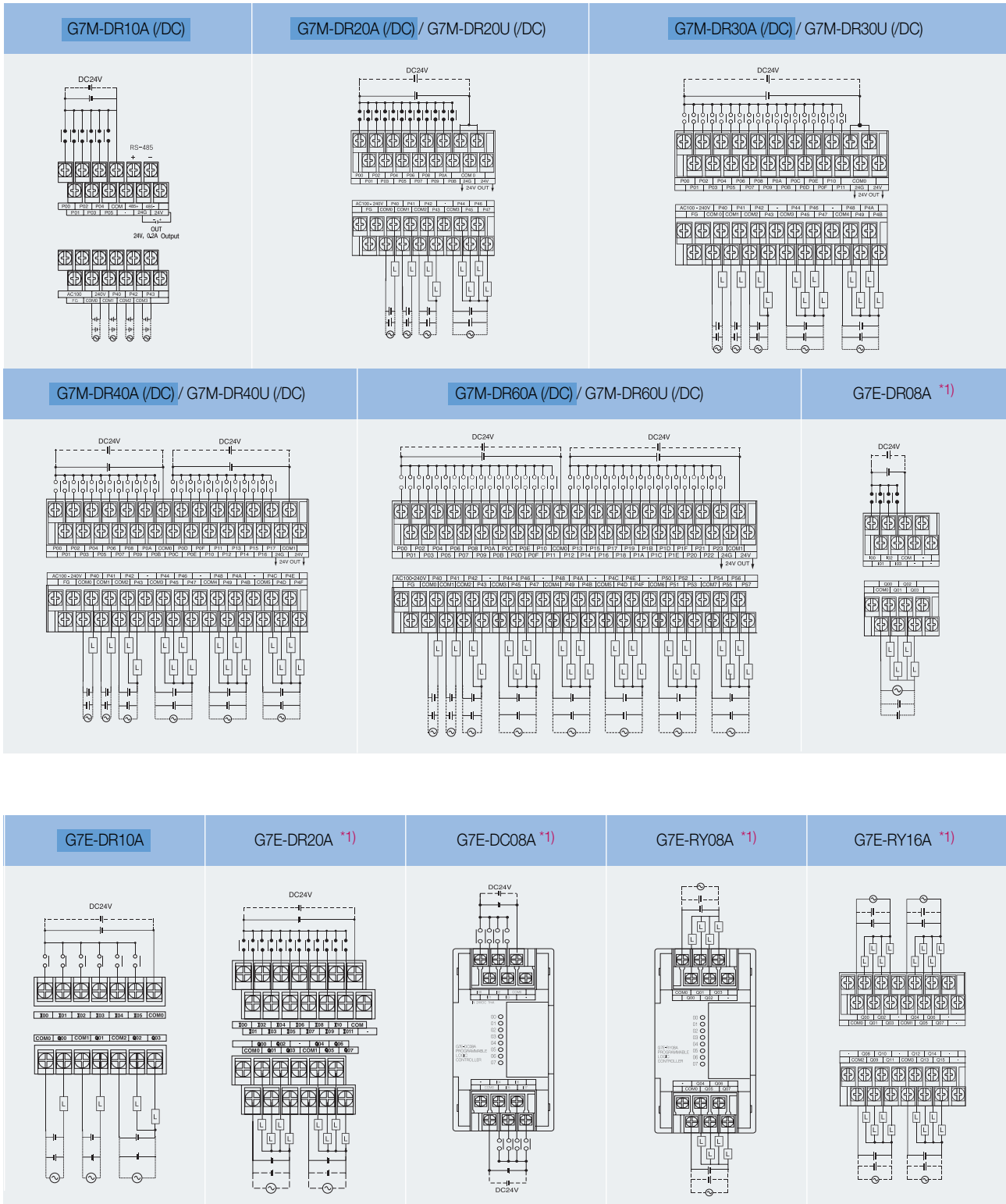

*1) GM7U only

* All the /DC types need DC24V for their operation and they don't supply DC24V output.

* stands for GM7 series

* Refer to user's manual for wiring.

■ GM7 DT Output

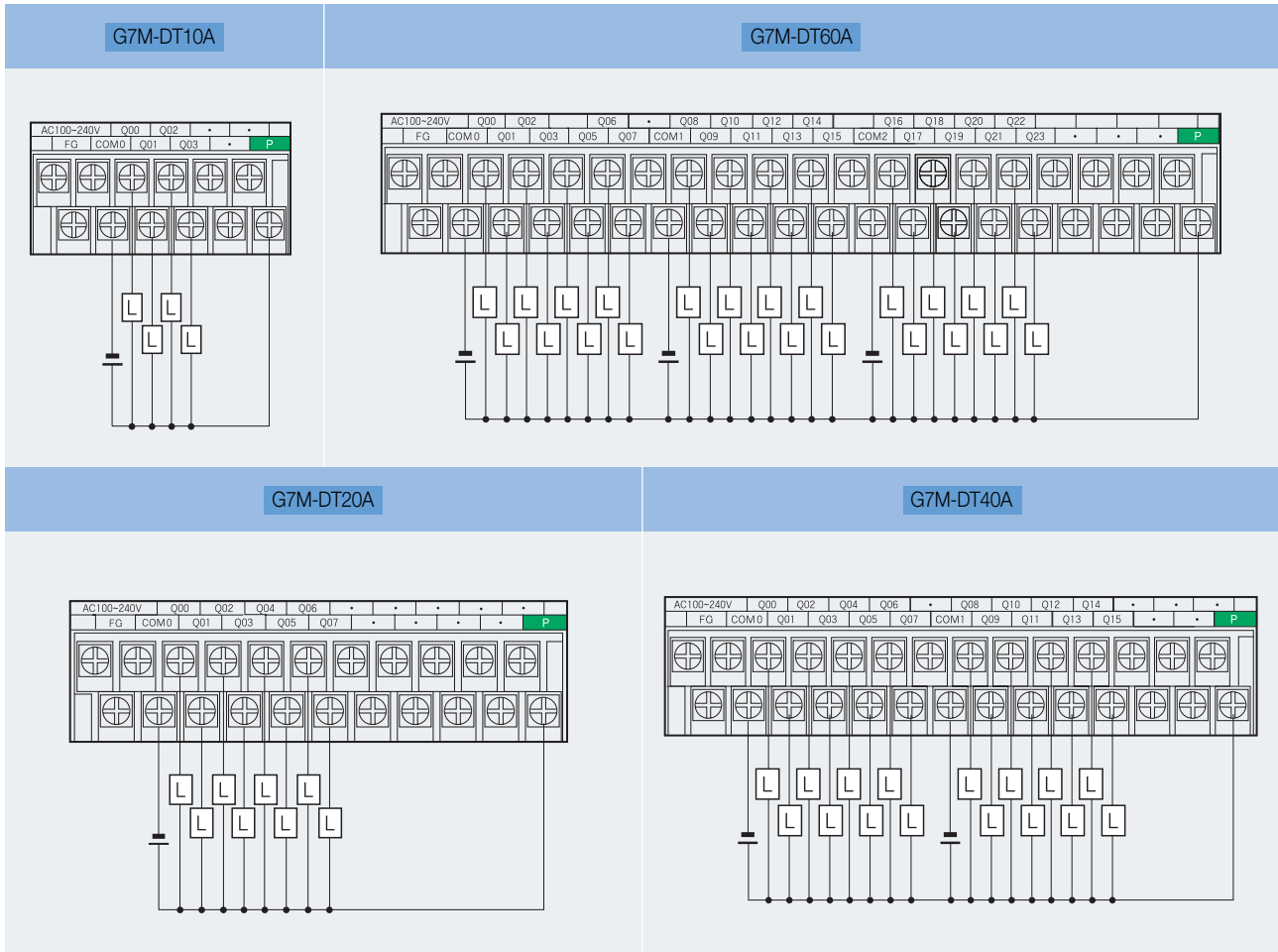

■ GM7U DT/DRT output

■ Output expansion unit

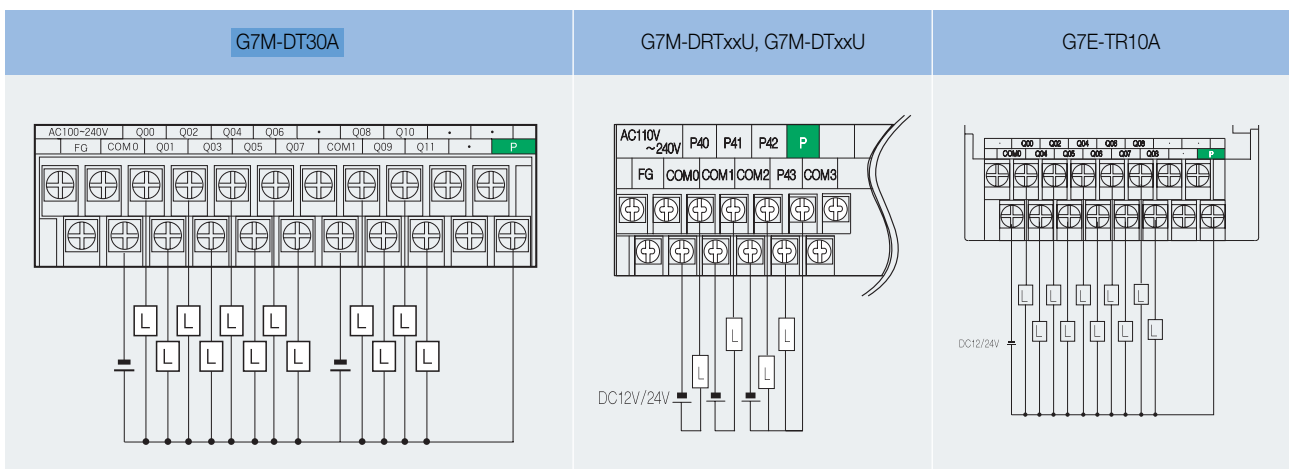

* Input terminal of transistor output modules is identical to that of relay output.
 You should connect DC24V to P terminal when you use an external power supply for load operation.
 * Refer to user's manual for wiring.

GLOFA-GM7/GM7U expansion unit

Programmable Logic Controller

Analog input/output unit

Item		A/D • D/A Hybrid module		A/D Module	D/A Module		
		G7F-ADHA (C) *1)	G7F-ADHB	G7F-AD2A (B) *2)	G7F-DA2I	G7F-DA2V	
Analog input	Input range	Voltage	DC 0~10V (Input resistance: More than 1 MΩ)				
		Current	DC 0~20mA (Input resistance 250 Ω) DC 4~20mA (Input resistance 250 Ω) Classified by parameter				
	Digital output	12 bits (0~4,000)					
	Voltage/current selection	Set by jumper pin for V/I selection upper part of product (Up: V, down: I)	Set by dip S/W for V/I selection on left side of product (Left: V, right: I)	Set by input terminal (When current input is used, short the V and I terminal)			
			V/I selected by GMWIN parameter Short V and I terminal when current input is used.				
	No. of channel	2Ch/module		4Ch/module			
Absolute max. Input	V	DC+12V		DC±15V			
	I	DC+24mA		DC±25mA			
Analog output	Output range	V	DC 0~10V (External load resistance 2 kΩ ~ 1 MΩ)		DC 0~20mA (Load resistance 510 Ω) DC 4~20mA (Load resistance 510 Ω)	DC 0~10mA (Load resistance 2 kΩ ~ 1 MΩ)	
		I	DC 0~20mA (External load resistance 510 Ω) DC 4~20mA (External load resistance 510 Ω) Classified by parameter				
	Digital input	12 bits (0~4,000)			12 bits (0~4,000)		
	Voltage/current selection	Separated from terminal					
	No. of channel	1Ch/module	2Ch/module		4Ch/module		
	Absolute V max. output	V	DC +12V		DC +24mA DC +12V		
I		DC +24mA					
Common	Max. resolution	V	DC 0~10V: 2.5mV (1/4000)		DC 0~20mA: 5μA (1/4000)		
		I	DC 0~20mA: 5μA (1/4000)		2.5mV (1/4000)		
		V	DC 4~20mA: 6.25μA (1/3200)		DC 4~20mA: 6.25μA (1/3200)		
		I	DC 4~20mA: 6.25μA (1/3200)				
	Accuracy	±0.5% (Full scale)			0.5%		
	Max. conversion speed	1ms/Ch + scan time (GM7U), 2ms/Ch + scan time (GM7)500μs*3) + scan time 1ms*3) + scan time					
Insulation	Photocoupler insulation between I/O terminal and PLC power supply (Non-insulation between channels).						
Connect terminal	9 points 2 terminals	8 points 2 terminals	2 points/16 points terminals	16 points terminal	8 points 2 terminals		
Internal current consumption	20mA	20mA	100mA	20mA	15mA		
External power supply	V	DC 21.6~26.4V					
	I	80mA	95mA	100mA	80mA	90mA	
Weight	240g	180g	300g	280g	160g		

※ Caution for wiring • 2-core, shielded twisted pair cable is recommended. Size: AWG22 (0.3mm) or higher.

• Wiring with high voltage or generation line, it makes induction failure which may cause malfunction or be out of order.

*1) Input voltage range of G7F-ADHC is DC 0~1V and the rest features are equal to those of G7F-ADHA. This is available at GM7U

GM7 only: G7F-ADHA, G7F-AD2A (B)

*2) G7F-AD2B is a slim type

*3) 500μs G7F-DA2I is for all channels. So it is 1ms in G7F-DA2V.

* Slim type: G7F-ADHB, G7F-AD2B, G7F-DA2V, G7F-RD2A

■ G7F-RD2A

Item	Specifications	
Connectable RTD	• Pt100 (JIS C1640-1989, DIN 43760-1980) • JPt100 (KS C1603-1991, JIS C1604-1981)	
Temperature input range	• Pt100: -200~600°C (18.48 to 313.59 Ω) • JPt100: -200~600°C (17.14 to 317.28 Ω)	
Digital output	• Digital conversion value: 0~4,000 • Detected temperature value: -2000~6000 (10-time scaled up value)	
Burnout detection	Each of three wires at every channel has detection function	
Accuracy	±0.5% (Full scale)	
Maximum conversion speed	40scan/module	
Number of temperature input device points	4 channels/module	
Insulation method	Photocoupler insulation between the input terminal and PLC power supply (Non-insulation between channels)	
Connection terminal block	Two 8-point terminal blocks	
Internal current consumption	25mA	
External power supply	V	DC 21.6~26.4V
	I	70mA
Weight	240g	

■ G7F-AT2A

Item	Specification
Channels	4
Output value range	8 bits (0 ~ 200)
Setting type	Setting by variable resistance
Accuracy of timer	±2.0% (Accuracy about max. value)
Internal current consumption	50mA
Weight	200g

Communication unit

■ Cnet modules (G7L-CUEB, G7L-CUEC)



Item		Specifications
Interface		G7L-CUEB: RS-232C (Modem), G7L-CUEC: RS-422/485
Communication mode	Dedicated mode	Supports 1:1, 1:N and high-speed link
	GMWIN mode	Supports remote programming and mounting via GMWIN
	Modbus mode	Supports master and slave function with Modbus protocol (ASCII, RTU)
	User-defined mode	Supports user-defined communication
Data structure	Data bit	7 or 8
	Stop bit	1 or 2
	Start bit	1 or 2
	Parity bit	EVEN/ODD/NONE
Synchronization		Asynchronous method
Transmission speed		1,200 / 2,400 / 4,800 / 9,600 / 19,200 / 38,400 / 57,600bps
Setting method		Communication parameter setting in GMWIN
Distance		Max. 15m (CUEB), Max. 500m (CUEC)
Max. number of stations		Max. 32 stations
Weight		180g

■ Fnet/Rnet module (G7L-FUEA/RUEA) *1)



Item		Specifications
Transmission speed		1Mbps
Communication	Segment	Max. 750m
	Repeater (Up to 6)	Max. 5.25km
Max. number of stations		Max. 64 stations
Setting method		Communication parameter setting in GMWIN
Cable		Shielded twisted pair cable
Weight		220g

*1) Rnet is a dedicated protocol for LSIS SMART I/Os.

■ Pnet module (G7L-PBEA)



Item		Specifications
Network type		Profibus-DP (Slave)
Protocol		EN50170/DIN19245
Media access		Token passing & Poll
Transmission and speed		1200m (9.6~187kbps) / 400m (500kbps) / 200m (1.5Mbps) / 100m (3~12Mbps)
Max. Node	Network	127 stations
	Segment	32 stations
Interface		RS-485 (electric)
Setting method		Communication parameter setting in GMWIN
Cable		Shielded twisted pair cable
Weight		210g

■ Dnet module (G7L-DBEA)



Item		Specifications			
Network structure		Trunk/drop line			
Protocol		Peer explicit message, Predefined explicit message Predefined I/O message (Poll, bit strobe, COS, cyclic)			
Max. extension & speed	Speed	Network distance	Drop cable	Total drop cable	
	500kbps	100m or less	6m or less	39m or less	
	250kbps	250m or less	6m or less	78m or less	
	125kbps	500m or less	6m or less	156m or less	
Channel		64 stations			
Diagnosis function		CRC error check/Scan list			
Setting method		Communication parameter setting in GMWIN			
Cable		5 lines (signal 2 lines, power 2 lines, shield 1 line)			

* 1) In case of GM7, only 1 communication module is available and you are not able to use a communication module and built-in Cnet at the same time because they are set as CH0 in GMWIN parameter. You are not able to connect a communication module to G7M-DR10A (/DC) and G7M-DT10A, which support either RS-232C or RS-485, and you can select a communication channel using a dip switch (built-in). If it is on, RS-232C is enabled and if it is off, RS-485 is activated.

* 2) In case of GM7U, only 1 communication module is available and you are not able to use a communication module and built-in RS-232C at the same time because they are set as CH0 in GMWIN parameter. Besides you are able to use both CH0 and built-in RS-485 (CH1) simultaneously. For more information, refer to P8 and P18.

GLOFA-GM7/GM7U expansion unit

Programmable Logic Controller

■ GM7U type

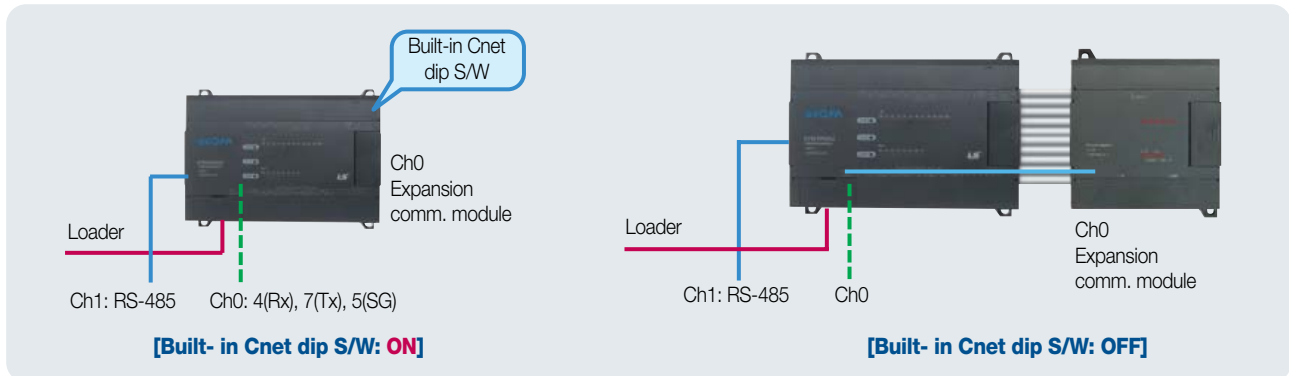

When built-in dip S/W is on, you are not supposed to use an expansion communication module while the built-in Cnet port is enabled, and if it's off, you can use an expansion communication module but the built-in Cnet port is disabled.

■ GM7 type

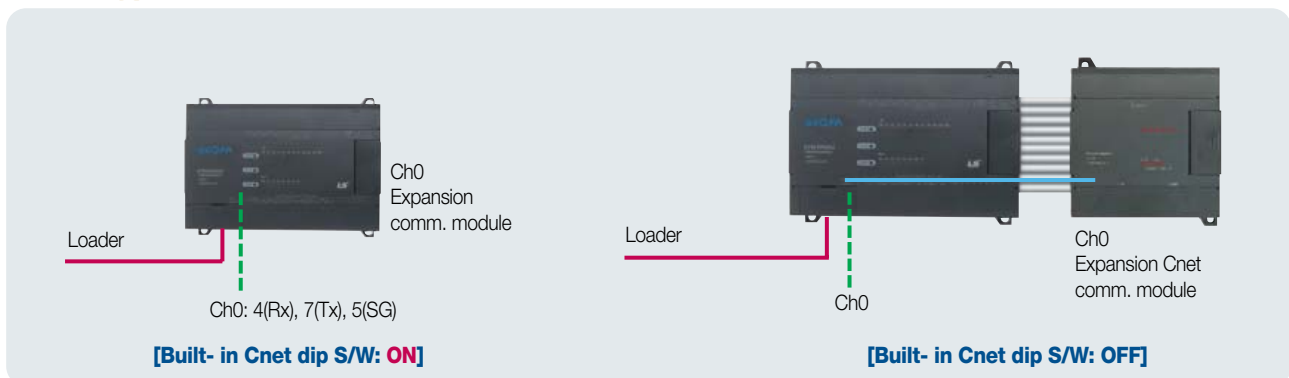

1. Only one channel (Ch0) for communication except the loader port is available in economic types.
2. When the built-in dip S/W is on, you are not supposed to use an expansion Cnet module while the built-in Cnet port is enabled, and if it's off, you can use an expansion communication module but the built-in Cnet port is disabled.

■ GM7 10-point type: G7M-DR10A (/DC), G7M-DT10A

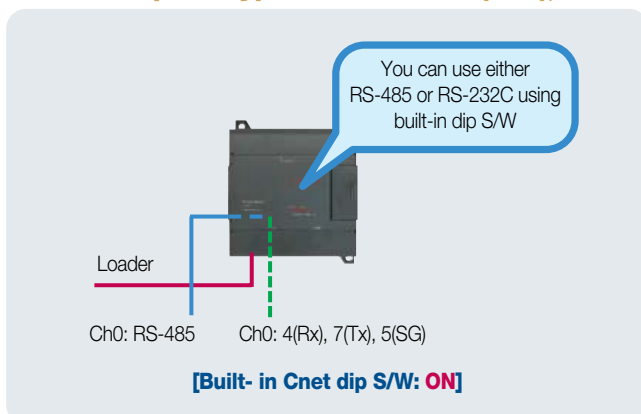

1. If the built-in Cnet dip S/W is on, you are able to use RS-232C (4, 7, 5 pins) as Ch0 and if it is off, RS-485 is enabled as Ch0.
2. With these modules you are not supposed to connect a modem to RS-232C for download/upload, monitoring or controlling. To use a dedicated/dial-up modem, you are required to use G7L-CUEB as expansion comm. module and before applying a modem, please contact LSIS.
3. You are able to use an expansion Cnet module when you do not use built-in Cnet (RS-232C/485) after turning off the built-in Cnet dip switch. In this case, no other device is connected to the built-in RS-485 port.

Block type PLC configuration

Programmable Logic Controller

System configuration for GM7

Item	System configuration
GM7	<ul style="list-style-type: none"> • Available system (max. 3 units in total) • Digital I/O: max. 2 units • Analog I/O: max. 2 units • Analog timer: max. 3 units • Communication I/F: 1 unit

System configuration



* I/O assignment applies to digital expansion module. For example, if an analog module is used at the 1st expansion and digital I/O is used at the 2nd expansion, then, the input of 2nd expansion module is from %Ix0.2.0 and the output is from %Qx0.2.0 And I/O assignment of GM7 and GM7U is equal

System configuration (GM7)

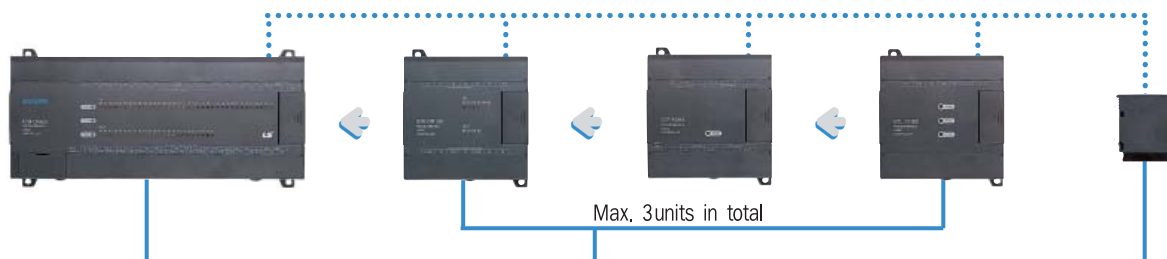

<p>Base unit</p> <ul style="list-style-type: none"> • Processing speed: 0.5 μs • Program capacity: 7k steps • Type: G7M-DR10A G7M-DR10A/DC G7M-DR20A G7M-DR20A/DC G7M-DR30A G7M-DR30A/DC G7M-DR40A G7M-DR40A/DC G7M-DR60A G7M-DR60A/DC G7M-DT10A G7M-DT40A G7M-DT20A G7M-DT60A G7M-DT30A 	<p>Expansion unit</p> <ul style="list-style-type: none"> • Digital I/O *1) <ul style="list-style-type: none"> - G7E-DR10A: DC in 6 points/relay out 4 points • Special unit <ul style="list-style-type: none"> - G7E-ADHA: Analog I/O(Input 2 channels, output 1 channel) - G7E-AD2A, G7F-AD2B: Analog input (4 channels) - G7E-AT2A: Analog timer (4 points) • Communication unit *2) <ul style="list-style-type: none"> - Cnet: RS-232C, RS-422 - Fnet (Master) - Fnet (Master) - DeviceNet (Slave) - Profibus-DP (Slave) 	<p>Option Pack</p> <ul style="list-style-type: none"> • G7E-RTCA: RTC (Real time clock) pack • G7E-M256: Memory pack (For program back-up) <p>Available System (3 units in total) *3)</p> <ul style="list-style-type: none"> • Digital I/O: Max. 2 units • Analog I/O: Max. 2 units • Analog Timer: Max. 3 units • Communication I/F: Max. 1 unit
---	--	---

- Option Pack**
- Base unit used: Connect to the expansion connector of the basic unit.
 - Expansion unit connected: Connect to the expansion connector of the last connected one.
 - You are able to use only one option pack.

*1) When digital I/Os are used, the 1st expansion input is assigned from %Ix0.0.0 and its output from %Qx0.0.0. The 2nd expansion input is from %Ix0.1.0 and its output from %Qx0.1.0 and so on. I/O allocation does not apply to other expansion modules. It does only to digital expansion modules.
 *2) You are not able to connect a communication module to G7M-DR10A(DC) and G7M-DT10A while you can do a communication module to other types of GM7. Built-in Cnet and a communication module share the same communication port and you are not able to use them at the same time.
 *3) Option pack is not included.

Block type PLC configuration

Programmable Logic Controller

■ System configuration for GM7U

Base unit

- Processing speed: 0.1 μ s
- Program capacity: 132k
- 32 types:
 - G7M-DR/DRT/DT20U (N/P) *1 (/DC)
 - G7M-DR/DRT/DT30U (N/P) (/DC)
 - G7M-DR/DRT/DT40U (N/P) (/DC)
 - G7M-DR/DRT/DT60U (N/P) (/DC)

*1) (N): NPN Tr., (P): PNP Tr.

Max. number of expansion unit installation

- Max. 3 units in total

Installation	Max. number of installation
Digital I/O	3
Analog I/O	3
Analog timer	3
Communication I/F	1

- You are able to connect an option pack to the connector of the last expansion module

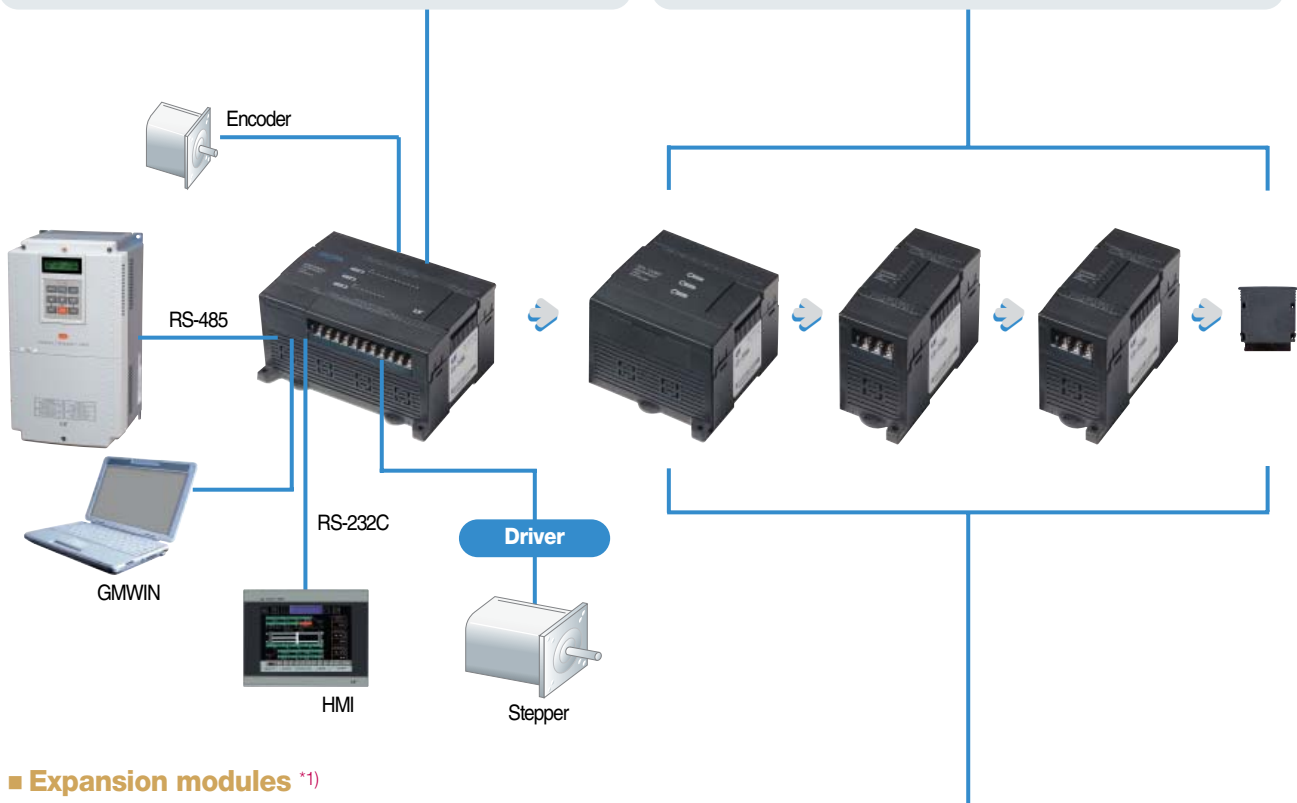

■ Expansion modules *1)

Digital I/O modules

- Input
 - G7E-DC08A *2): DC input 8 points
- Output
 - G7E-TR10A *2): Tr output 10 points
 - G7E-RY08A *2): Relay output 8 points
 - G7E-RY16A *2): Relay output 16 points
- Input/Output
 - G7E-DR08A *2): DC in 4 points / relay out 4 points
 - G7E-DR10A: DC in 6 points / relay out 4 points
 - G7E-DR20A *2): DC in 12 points / relay out 8 points

Special modules

- A/D
 - G7F-AD2A, G7F-AD2B : Analog input (4 channels)
- D/A
 - G7F-DA2V *2): Voltage output (4 channels)
 - G7F-DA2I *2): Current output (4 channels)
- A/D, D/A
 - G7F-ADHA: Analog (in 2 channels, out 1 channel)
 - G7F-ADHB *2): Analog (in 2 channels, out 2 channels)
 - G7F-ADHC *2): Analog (in 2 channels, out 1 channel)
- RTD
 - G7F-RD2A *2): RTD 4 channels
- Analog timer
 - G7F-AT2A: Analog timer (4 points)

Communication unit *3)

- G7L-CUEB: RS-232C 1 channel
- G7L-CUEC: RS-422 1 channel
- G7L-FUEA: Fieldbus I/F (Fnet master)
- G7L-RUEA: Fieldbus I/F (Rnet master)
- G7L-DBEA: DeviceNet (slave)
- G7L-PBEA: Profibus-DP (slave)

Option pack

- G7E-RTCA: RTC (Real timer clock) pack
- G7E-M256B: Memory pack (for program back-up)

*1) I/O assignment is the same as that of GM7.

*2) GM7U only. And  stands for a slim type

*3) Built-in RS-232C and a communication module shares the same communication port (CHO) and you are not able to use them at the same time. In case of GM7U, you are able to use built-in RS-485 (CH1) and a comm. module (CHO) at the same time.



GLOFA-GM6

Programmable Logic Controller

■ Features

- High performance features with compact size
- High-speed processing using dedicated CPU
- Designed by international standard language (IEC61131-3): IL, LD, SFC
- Max. I/O points: 384 points



■ Specifications

GM6		GM6-CPUA	GM6-CPUB	GM6-CPUC	Remark
Operation method		Cyclic execution of stored program, Time-driven operation, Internal task operation			
I/O control method		Scan synchronized batch processing method (Refresh method)			
Program language		IL (Instruction list) / LD (Ladder diagram) / SFC (Sequential function chart)			
Number of Instructions	Operator	LD: 13, IL: 20			
	Standard function	194			
	Standard function block	12			
	Special function block	Each special module has its own special function block			
Processing speed	Operator	0.5 μ s/instruction			
	Standard function	0.5 μ s/step			
	Standard function block				
Programming memory capacity		68K			Built-in flash memory (128K)
I/O points	With 32-pt modules	192 points			
	With 64-pt modules	384 points			
	With remote I/Os	512 points			
Data memory	Direct variable area (DVA)	2~8K			Setting in GMWIN
	Symbolic variable area (SVA)	30K - Direct variable area			
Timer		No limitation. Time range: 0.001~4294967.295 sec (1193 hours)			20 bytes per 1 timer in SVA
Counter		No limitation. Count range: -32,768~32,767			8 bytes per 1 counter in SVA
Operation mode		RUN, STOP, PAUSE, DEBUG			
Data retention at power failure		Set to 'Retain' at data declaration			
Number of program blocks		100			
Program type	Task	Scan	100 - (Number of program blocks in task)		8 in total
		Time-driven	8		
		External interrupt	8		
		Internal	8		
		Initialization	1 (_INIT)		
Self-diagnostic functions		Watchdog timer, Memory error, I/O error, Battery error, Power supply error			
Restart mode		Cold, Warm			
Base type		4/6/8/12 slot *1)			Expansion is not available
Built-in functions		• Cnet (RS-232C) *2)	• PID control • Cnet (RS-422/485) • RTC function	• PID control • Cnet (RS-232C) *2) • HSC (50kHz) • RTC function	
Internal current consumption		170mA	210mA	170mA	

*1) In case of GM6-B12M, the module installed in slot number 8 or later is designated as base number 1 and slot number 0 or later; the suitable power module for GM6B12M is GM6-PAFC, which can't support an analogue module. For analog modules or TC module, you are supposed to use GM6-PAFB or GM6-PDFB considering internal current consumption of each module.

Communication modules are not to be installed in after slot number 7.

*2) Built-in RS-232C port: 4 (Rx), 7 (Tx), 5 (SG)



GLOFA-GM6

Programmable Logic Controller

Input modules

Input module specifications

Input type		DC Input					AC Input *1)	
Part number	G6I-D21A	G6I-D22A	G6I-D22B	G6I-D24A	G6I-D24B	G6I-A11A	G6I-A21A	
Input point	8 points	16 points			32 points	8 points		
Rated input voltage	DC12/24V	DC12/24V	DC24V	DC12/24V	DC24V	AC100~120V	AC200~240V	
Rated input current	3/7mA	3/7mA	7mA	3/7mA	7mA	7mA	11mA	
On voltage/current	DC9.5V or more/ 3.5mA or more	DC9.5V or more/ 3.5mA or more	DC15V or more/ 4.3mA or more	DC9.5V or more/ 3.5mA or more	DC15V or more/ 4.3mA or more	AC80V or more/ 5mA or more	AC80V or more/ 5mA or more	
Off voltage/current	DC5V or less/ 1.5mA or less	DC5V or less/ 1.5mA or less	DC5V or less/ 1.7mA or less	DC5V or less/ 1.5mA or less	DC5V or less/ 1.7mA or less	AC30V or less/ 2mA or less	AC30V or less/ 2mA or less	
Response time	Off→On On→Off	5ms or less 5ms or less	5ms or less 5ms or less	5ms or less 5ms or less	5ms or less 5ms or less	15ms or less 25ms or less	15ms or less 25ms or less	
Common		8 points/COM			32 points/COM		8 points/COM	
Operating indicator		LED						
Insulation method		Photocoupler insulation						
Current consumption (DC5V)		40mA	70mA	75mA		35mA		

*1) AC input modules: 50/60Hz

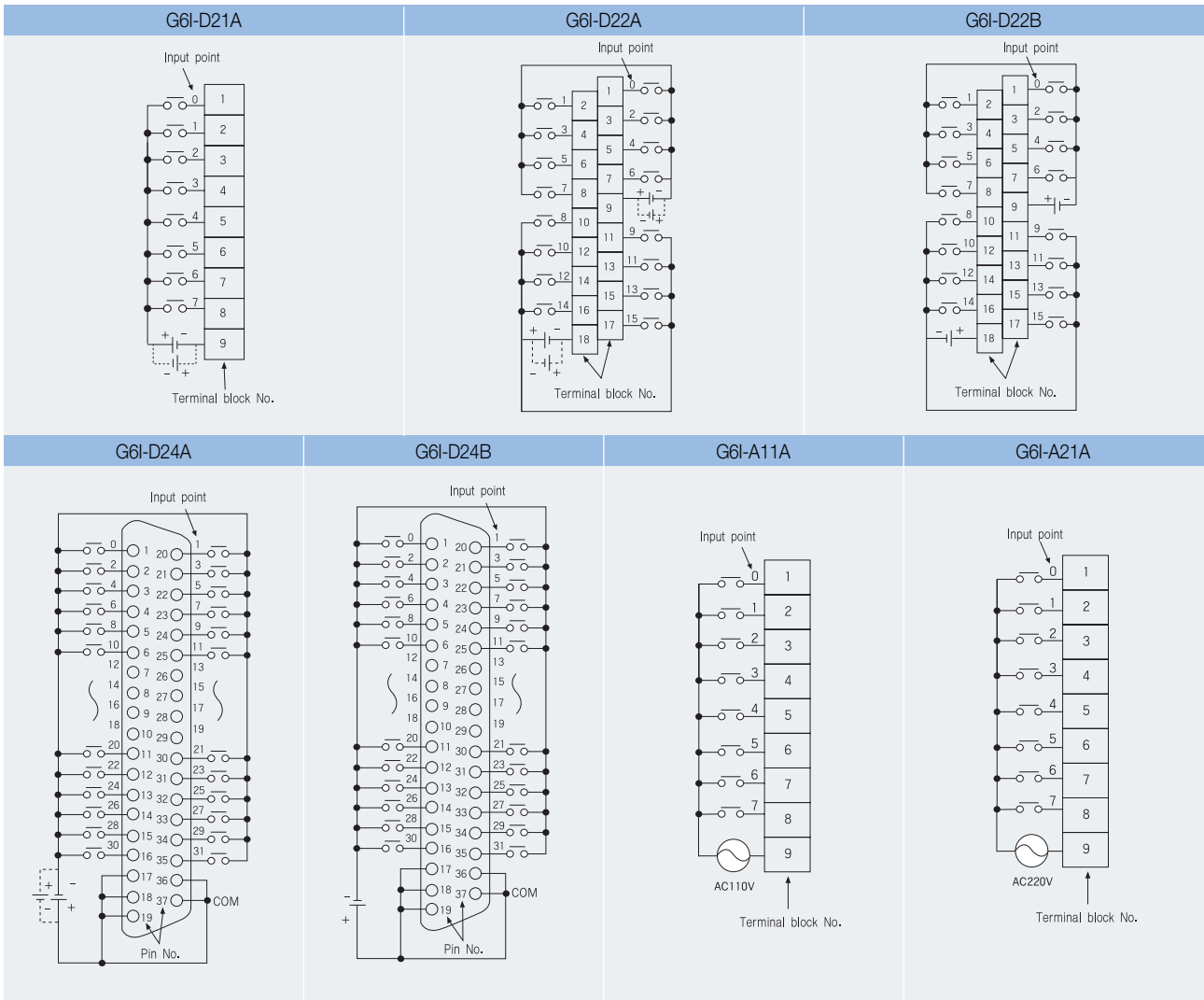

* Refer to user's manual for wiring.

Output modules

Output module specifications

Output module type		Relay output			Transistor output				Triac output
Part number		G6Q-RY1A	G6Q-RY2A	G6Q-RY2B	G6Q-TR2A	G6Q-TR2B	G6Q-TR4A	G6Q-TR4B	G6Q-SS1A
Output point		8 points	16 points		16 points	16 points	32 points	32 points	8 points
Rated load voltage		DC12/24V, AC110/220V (50/60Hz)			DC12/24V				AC110/220V (50/60Hz)
Off leakage current					0.1mA or less				2.5mA or less
On voltage drop		-			DC1.5V or less	DC2.5V or less	DC3V or less		AC1.5V or less
Rated load current	1 Point	2A			0.5A	0.1A			1A
	1 Common	-	5A		3A	2A			4A
Response time	Off → On	10ms or less			2ms or less				1ms or less
	On → Off	12ms or less			2ms or less				0.5cycle+1ms or less
Common		1 point/COM	8 points/COM		16 points/COM	32 points/COM		8 points/COM	
Operating indicator					LED				
Insulation method		Relay			Photocoupler				
Surge absorber		-			Varistor		Clamp diode		Varistor, CR absorber
Current consumption (DC5V)		210mA	400mA		180mA	170mA	140mA	145mA	190mA
External power supply		-			DC24V				-

* G6Q-TR2A/TR4A: Sink type, G6Q-TR2B/TR4B: Source type

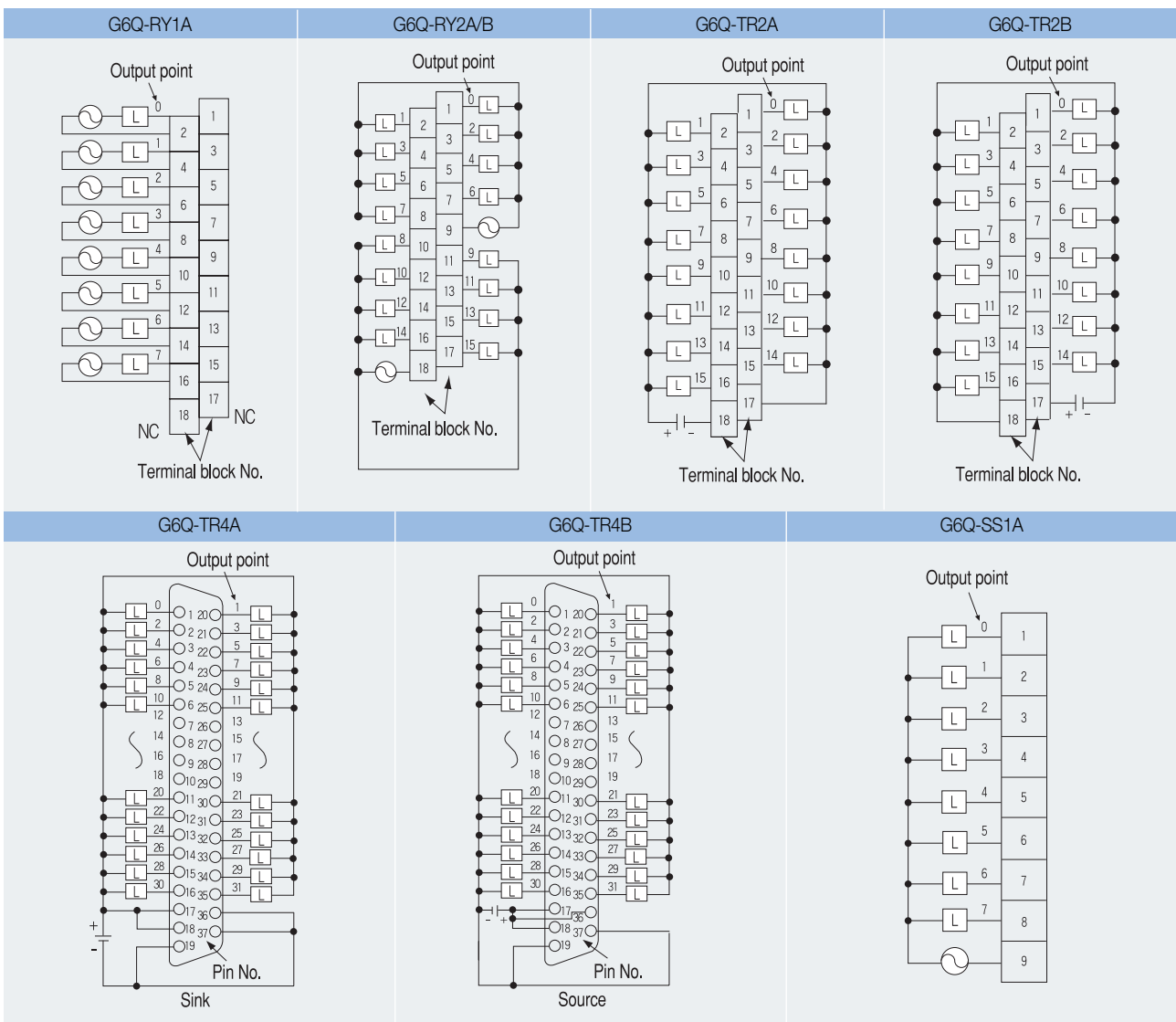

* Refer to user's manual for wiring.



GLOFA-GM6

Programmable Logic Controller

I/O hybrid module specifications

G6H-DR2A			
Input		Output	
Input point	8 points	Output point	8 points
Insulation method	Photocoupler	Insulation method	Relay
Rated input voltage	DC 12/24V	Rated load	DC 24V, 2A (Resistance)/1 point, 4A/COM voltage/current AC 220V, 2A (COS ϕ =1)/1 point, 4A/COM
Rated input current	3/7mA	Min. load voltage/current	DC 5V/1mA
Operating voltage range	DC 10.2~28.8V (Ripple rate < 5%)	Max. load voltage	AC 250V, DC 125V
Max. simultaneous input	8 points (100% simultaneous ON)	Off leakage current	0.1mA (AC 220V, 60Hz)
On voltage/current	DC 9.5V/3.5mA or more	Max. switching frequency	1,200 times/hour
Off voltage/current	DC 5V/1.5mA or less	Surge absorber	-
Input impedance	About 3.3k Ω	Service life	Mechanical 20 million times or more Electrical 100,000 times or more (Rated load V/C)
Response time	Off \rightarrow On 5ms or less On \rightarrow Off 7ms or less	Response time	Off \rightarrow On 10ms or less On \rightarrow Off 12ms or less
-	-	-	-
Common	8 points/COM	Common	8 points/COM
Operating indicator	LED	Operating indicator	LED
External connection	18-point terminal block connector (M3 \times 6 screws)		
Current consumption (DC 5V)	250mA		
Weight	200g		

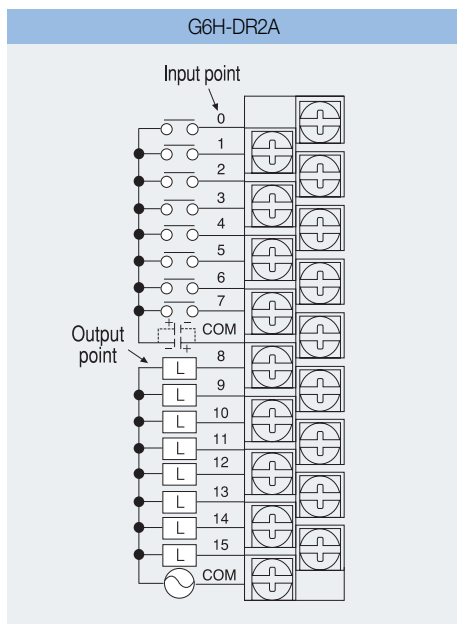

* Refer to user's manual for wiring.



GLOFA-GM4

Programmable Logic Controller

■ Features

- Max. I/O points: GM4A/B (2,048), GM4C (3,584)
- Fast processing time with high-speed gate array
- Fit for small- and medium-sized manufacturing line network
- In case of remote system configuration, large-scale control available
- Cnet, DeviceNet, Fast Ethernet, Fnet, Profibus-DP, Rnet support
- Downsizing and high performance/function
- Special function modules
 - Analog I/O, PID, High-speed counter, Position control (APM), AT, TC, RTD, etc



■ Specifications

GM4		GM4-CPUA	GM4-CPUB	GM4-CPUC	Remark
Operation method		Cyclic execution of stored program, Time-driven operation, Internal task operation			
I/O control method		Scan synchronized batch processing method (Refresh method)			
Program language		IL (Instruction list) / LD (Ladder diagram) / SFC (Sequential function chart)			
Number of Instructions	Operator	LD: 13, IL: 20			
	Standard function	194	194+ 'Real number function'		
	Standard function block	12			
	Special function block	Each special module has its own special function block			
Processing speed	Operator	0.2 μs/instruction		0.12 μs/instruction	
	Standard function	0.2 μs/step		0.12 μs/step	
	Standard function block				
Real number operation		No		Yes	
Programming memory capacity		128K (32Ksteps)		1M	
I/O points	With 32-pt modules	1,024 points		1,792 points	
	With 64-pt modules	2,048 points		3,584 points	
	With remote I/Os	4,096 points	8,192 points	32,768 points	
Data memory	Direct variable area (DVA)	2~16K		8~64K	Setting in GMWIN
	Symbolic variable area (SVA)	52K-Direct variable area		428K-Direct variable area	
Timer		No limitation. Time range: 0.001~4294967.295 sec (1193 hours)			
Counter		No limitation. Count range: -32,768~32,767			20 bytes per 1 timer in SVA
Operation mode		RUN, STOP, PAUSE, DEBUG			8 bytes per 1 counter in SVA
Data retention at power failure		Set to 'Retain' at data declaration			
Program type	Scan	180 (Number of program blocks) - (Program blocks in task)			
	Task	Time-driven	8	32	
		External interrupt	8		
		Internal	16		
		Initialization	2 (_INIT, _H_INIT)		
Error	None	1 (_ERR_SYS)			
Self-diagnostic functions		Watchdog timer, Memory error, I/O error, Battery error, Power supply error			
Restart mode		Cold, Warm, Hot			
Flash memory		External (128K)	Built-in (512K)	Built-in (6M)	CPUC: Program 1M, Upload 5M
Program port		RS-232C		RS-232C, USB	
Maximum expansion stage		3		6 *	
Internal current consumption		130mA			

K: kilobyte

* For 6 stage expansion you need to use special base (main, expansion) and special expansion cable. Refer to P26 and P65, please.

GLOFA-GM4

Programmable Logic Controller

Configuration

■ GMWIN programming with IL, LD, and SFC



Power module			
AC 110V input	GM4-PA1A	DC 5V 4A DC 24V 0.7A	output
	GM4-PA1B	DC 5V 3A DC 24V 0.5A	output
AC 220V input	GM4-PA2A	DC 5V 4A DC 24V 0.7A	output
	GM4-PA2B	DC 5V 3A DC 24V 0.5A	output
DC 24V input	GM4-PA2C	DC 5V 8A output	
	GM4-PD3A	DC 5V 4A output	

CPU module	
Type	I/O points
GM4-CPUA	2,048 / 4,096
GM4-CPUB	2,048 / 8,192
GM4-CPUC	3,584 / 32,768

Memory module (Option)	
G4M-M032	128K *1)

Item	I/O module							
	Input module			Output module			I/O hybrid module	
	AC 110V	AC 220V	DC 12/24V	Relay	Triac	Transistor	DC/Relay	DC/Transistor
16 points	G4I-A12A	G4I-A22A	G4I-D22A G4I-D22B G4I-D22C	G4Q-RY2A	G4Q-SS2A G4Q-SS2B	G4Q-TR2A G4Q-TR2B	G4H-DR2A	G4H-DT2A
32 points	-	-	G4I-D24A G4I-D24B G4I-D24C	-	-	G4Q-TR4A G4Q-TR4B	-	-
64 points	-	-	G4I-D28A	-	-	G4Q-TR8A	-	-

Item	Base				
	I/O Slot	Main	Expansion	Main (H)	Expansion (H)
4		GM4-B04M	GM4-B04E	GM4-B4MH	GM4-B4EH
6		GM4-B06M	GM4-B06E	GM4-B6MH	GM4-B6EH
8		GM4-B08M	GM4-B08E	GM4-B8MH	GM4-B8EH
12		GM4-B12M *2)	-	-	-

Expansion cable		High function expansion cable	
0.4m	G4C-E041	0.6m	G4C-E061
1.2m	G4C-E121	6m	G4C-E601
3m	G4C-E301	10m	G4C-E102
		15m	G4C-E152

Communication module		
Fast Enet I/F (Open)	G4L-EUTB	10/100BASE-Tx, UTP
	G4L-EUFB	100BASE-Fx, Fiber optic
	G4L-EU5B	10BASE-5, AUI
Fast Enet I/F Dedicated (Master)	G4L-EUTC	10/100BASE-Tx, UTP
	G4L-EUFC	100BASE-Fx, Fiber optic
	G4L-EU5C	10BASE-5, AUI
Fast Enet I/F Dedicated (Slave)	G4L-ERTC	10/100BASE-Tx, UTP
	G4L-ERFC	100BASE-Fx, Fiber optic
	G4L-ER5C	10BASE-5, AUI
Fnet I/F	G4L-FUEA	1Mbps, Twisted pair cable
	G4L-FUOA	1Mbps, Fiber Optic
Rnet I/F	G4L-RUEA	1Mbps, Twisted pair cable
Dnet I/F	G4L-DUEA	DeviceNet Master/Slave
Pnet I/F	G4L-PUEA	Profibus-DP Master/Slave (1K)
	G4L-PU EB	Profibus-DP Master/Slave (7K)
Cnet I/F	G4L-CUEA	RS-232C/422 1Ch each

Special module		
Analog input	G4F-AD2A/G4F-AD3A	4/8 Ch
	G4F-DA1A	2 Ch
Analog output	G4F-DA2I/G4F-DA3I	4/8 Ch
	G4F-DA2V/G4F-DA3V	4/8 Ch
Thermocouple input	G4F-TC2A	4 Ch
RTD input	G4F-RD2A	4 Ch
Analog timer	G4F-AT3A	8 points
PID control	G4F-PIDB	16 loops
High speed counter	G4F-HSCA	1 Ch
	G4F-HD1A/G4F-HO1A	2 Ch
Position control	G4F-PPxD (X=1,2,3)	1/2/3 axes
Interrupt	G4F-INTA	16 points
Temperature control	G4F-TMCA	2 loops

*1) GM4-CPUB and GM4-CPUC have a built-in flash memory that you can't use memory module.

*2) In case of GM4-B12M, you can't extend I/O modules; the base and slot number of from slot number 8 to 11 is set as base number 1, slot number from 0 to 3.

In case of GM4-CPUA, you can't install a communication module after slot number 8.

Input/output modules

■ Features

- 16/32/64 points
- Operation status monitoring by LED
- Insulated by Photocoupler
- Easy maintenance with terminal block & one touch installation

■ Input module specifications

Input type		DC Input				
Part number		G4I-D22A/C *1)	G4I-D22B	G4I-D24A/C *1)	G4I-D24B	G4I-D28A *2)
Input point		16 points		32 points		64 points
Rated input voltage		DC 12/24V *1)				
Rated input current		5/11mA		3/7mA		3/6mA
On voltage/current		DC 9.5V or more/4mA or more			DC 9.5V or more/3mA or more	
Off voltage/current		DC 6V or less/1.0mA or less				
Response time	Off → On	10ms or less				
	On → Off	10ms or less				
Common		8 points/COM		32 points/COM		
Type		Source/Sink	Source (+COM)	Source/Sink	Source (+COM)	Source/Sink
Operating indicator		LED				
Insulation method		Photocoupler insulation				
Current consumption (DC 5V)		70mA		75mA		250mA

Input type		AC Input		Interrupt
Part number		G4I-A12A	G4I-A22A	G4F-INTA
Input point		16 points		8 points
Rated input voltage		AC 100~120V (50/60Hz)	AC 200~240V (50/60Hz)	DC 24V
Rated input current		11mA		10mA
On voltage/current		AC 80V or more/6mA or more	AC 150V or more/4.5mA or more	DC 15V or more
Off voltage/current		AC 30V or less/3mA or less	AC 50V or less/3mA or less	DC 5V or less
Response time	Off → On	15ms or less		0.5ms or less
	On → Off	25ms or less		0.5ms or less
Common		8 points/COM		1 point/COM
Operating indicator		LED		
Insulation method		Photocoupler insulation		
Current consumption (DC 5V)		70mA		

■ Output module specifications

Output type		Transistor output				
Part number		G4Q-TR2A	G4Q-TR2B	G4Q-TR4A	G4Q-TR4B	G4Q-TR8A
Output point		16 points		32 points		64 points
Rated load voltage		DC 12/24V				
Rated load current	1 Point	0.5A		0.1A		
	1 Common	3A/COM		2A/COM		
Response time	Off → On	2ms or less				
	On → Off	2ms or less				
Common		8 points/COM		32 points/COM		
Operating indicator		LED				
Type		Sink (-COM)	Source (+COM)	Sink (-COM)	Source (+COM)	Sink (-COM)
Insulation method		Photocoupler insulation				
Surge absorber		Varistor		-		
Current consumption (DC 5V)		100mA		160mA		250mA
External power supply		DC 24V				

Output type		Relay output		Triac output	
Part number		G4Q-RY2A *3)		G4Q-SS2A	G4Q-SS2B
Output point		16 points			
Rated load voltage		DC 12/24V, AC 110/220V (50/60Hz)		AC 100~240V (50/60Hz)	
Rated load current	1 Point	2A		1A	0.6A
	1 Common	4A/COM		5A/COM	2.4A/COM
Response time	Off → On	10ms or less		0.5cycle + 1ms or less	
	On → Off	12ms or less		0.5cycle + 1ms or less	
Common		8 points/COM			
Operating indicator		LED			
Type		-			
Insulation method		Photocoupler insulation			
Surge absorber		-		Varistor, CR absorber	
Current consumption (DC 5V)		100mA		330mA	
External power supply		DC24V		-	

*1) Rated input voltage for G4I-D2XC is DC24V and on voltage is 19.6V

*2) G4I-D28A and G4Q-TR8A are connector-type modules

*3) For G4Q-RY2A operation, you need to supply DC24V.

GLOFA-GM4

Programmable Logic Controller

Input/output modules

■ Wiring diagram for input modules

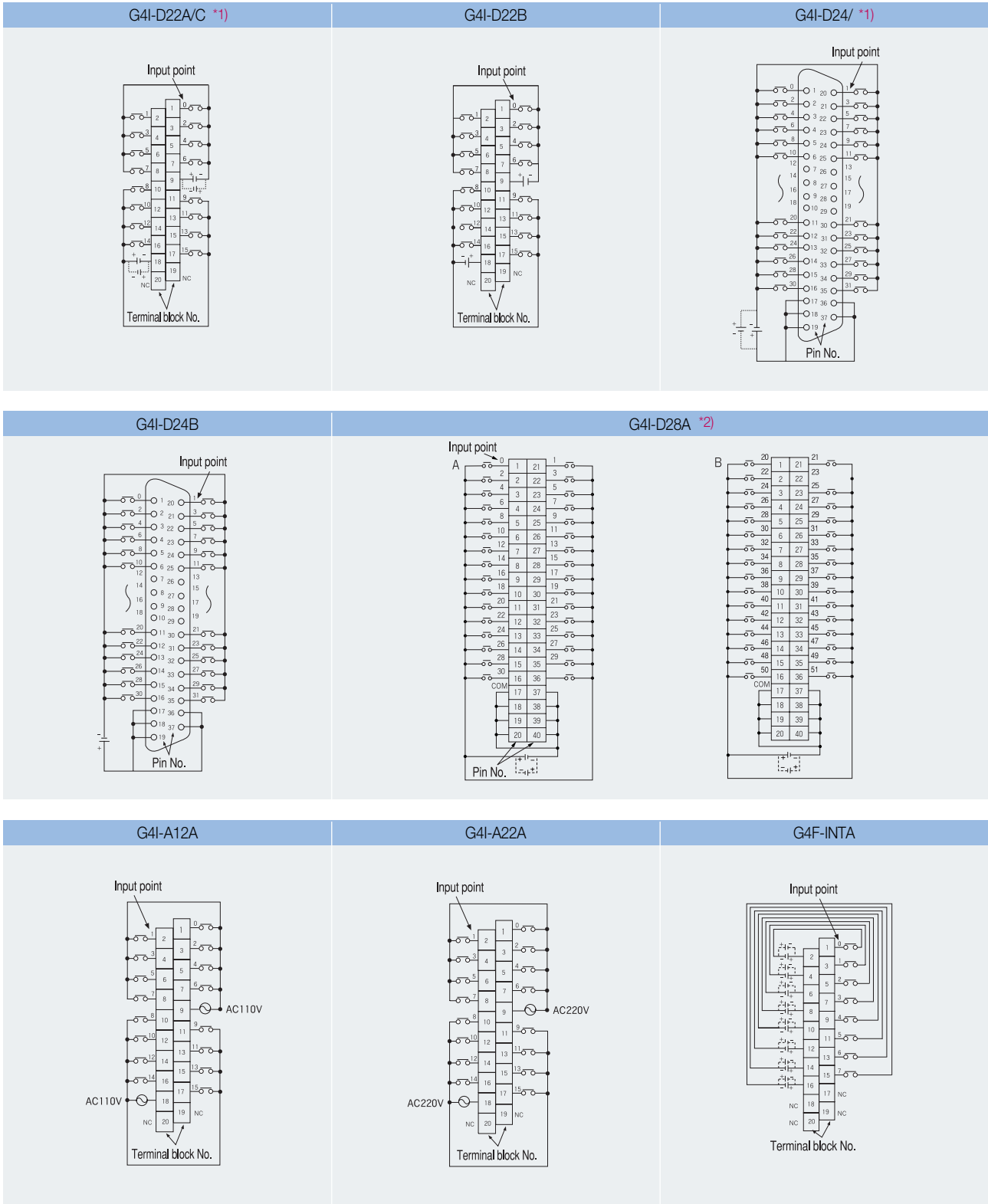

*1) Rated input voltage for G6I-D2XC is DC24V and on voltage is 19.6V.

*2) G4I-D28A is a connector-type module.

* Refer to user's manual for wiring.

■ Wiring diagram for output modules

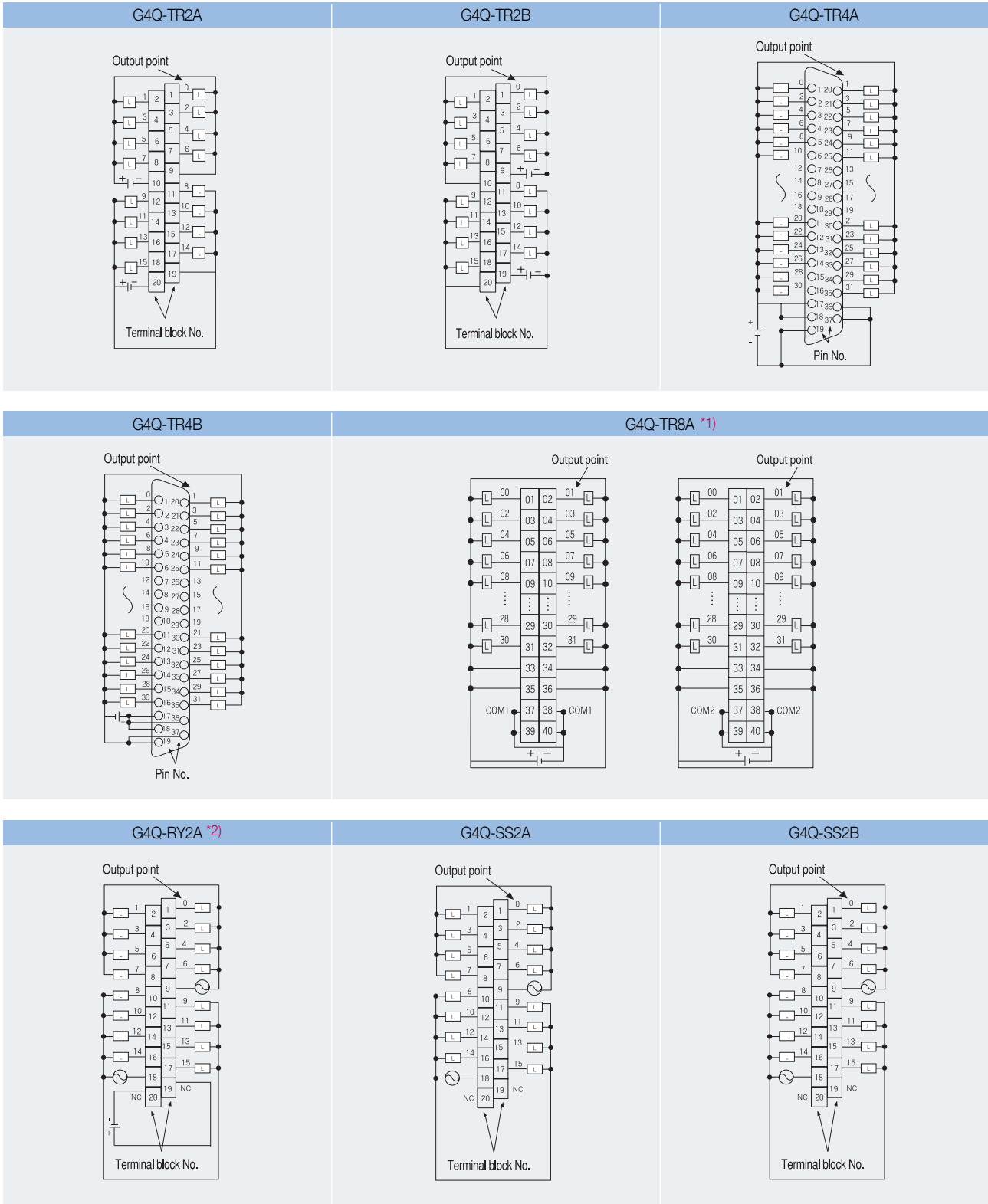

*1) G4Q-TR8A is a connector, type module.
 *2) For G4Q-RY2A operation, you need to supply DC24V.
 * Refer to user's manual for wiring.

GLOFA-GM4

Programmable Logic Controller

I/O hybrid module specifications

Input type		DC Input			
Part number		G4H-DT2A		G4H-DR2A *1)	
Input point		8 points			
Rated input voltage		DC 12V	DC 24V	DC 12V	DC 24V
Rated input current		5mA	11mA	5mA	11mA
On voltage/current		DC 9.5V or more/4.0mA or more			
Off voltage/current		DC 6V or less/1.0mA or less			
Response time	Off → On	10ms or less			
	On → Off	10ms or less			
Common		8 points/1COM			
Operating indicator		LED			
Insulation method		Photocoupler insulation			
Current consumption(DC 5V)		100mA			

Output type		Transistor output	Relay output
Part number		G4H-DT2A	G4H-DR2A
Output point		8 points	
Rated load voltage		DC 12/24V	DC 24V/AC 220V (50/60Hz)
On voltage drop		DC 1.5V or less	-
Off leakage current		0.1mA or less	
Rated load current		0.5A/1 point 3A/COM	2A/1 point 5A/COM
Response time	Off → On	2ms or less	10ms or less
	On → Off	2ms or less	10ms or less
Common		8 points/1COM	
Operating indicator		LED	
Insulation method		Photocoupler insulation	
Surge absorber		Varistor	-

Wiring diagram

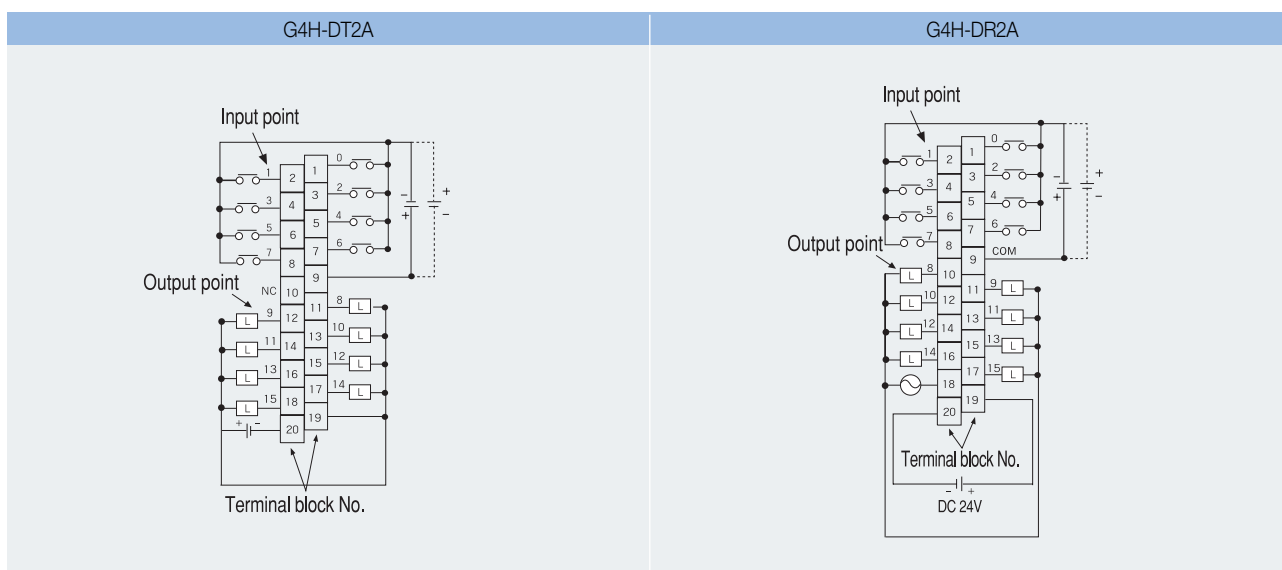

*1) For G4H-DR2A operation, you need to supply DC24V.

* Refer to user's manual for wiring.

System configuration

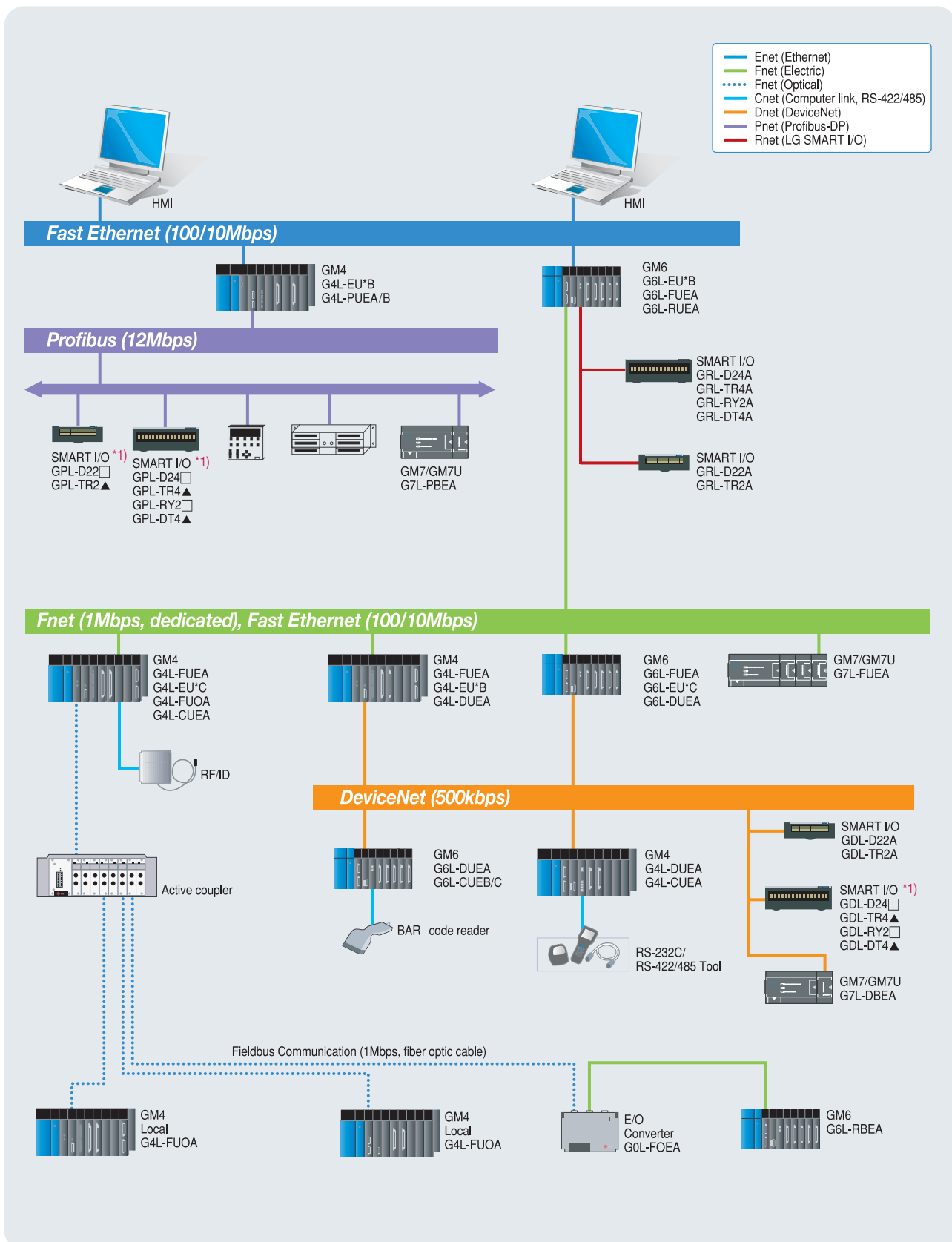

*1) Refer to P42, please.

GLOFA-GM Fast Enet (Ethernet) system

Programmable Logic Controller

■ Features

- 10/100BASE-TX, 100BASE-FX (optical), 10BASE-5 support
- High reliability and performance with 32-bit processor
- Open (Information level) Ethernet and LSIS dedicated (Between LS PLCs) Ethernet: 2 types
- User-defined protocol editing and connection to other system using function block: Open-type (-EUxB) only
- GMWIN service for remote programming, remote monitoring and PLC mode control



Specifications

■ Open Ethernet

Item		GxL-EUTB	GxL-EUFB *1)	GxL-EU5B
Network		10/100BASE-TX, UTP (TP)	100BASE-FX, Fiber optic	10BASE-5, AUI
Support protocol		TCP/IP, UDP/IP		
Service	With LS PLCs	High-speed link, Command service		
	With other devices	Command service		
	Application	GMWIN service, Dedicated protocol service		
Communication data		60 words/block or 200 words/block, 1446 bytes/frame		
Number of channels		16		
Usage		Communication between LS PLC and other devices (PC), High-speed link between LS PLCs		
Applicable type		GM6/GM4		GM4

■ Dedicated Ethernet

Item	Master	GxL-EUTC	GxL-EUFC *1)	GxL-EU5C
	Slave	GxL-ERTC	GxL-ERFC *1)	GxL-ER5C
Network		10/100BASE-TX, UTP (TP)	100BASE-FX, Fiber optic	10BASE-5, AUI
Support protocol		Token passing		
Service	With LS PLCs	High-speed link, Command service		
	With other devices	-		
	Application	GMWIN service		
Communication data		200 words/block		
Number of connecting stations		64		
Usage		High-speed link between LS PLCs		
Applicable type		GM6/GM4		GM4

*1) SC-type connector is used.

GLOFA-GM Ethernet system configuration

Programmable Logic Controller

System configuration

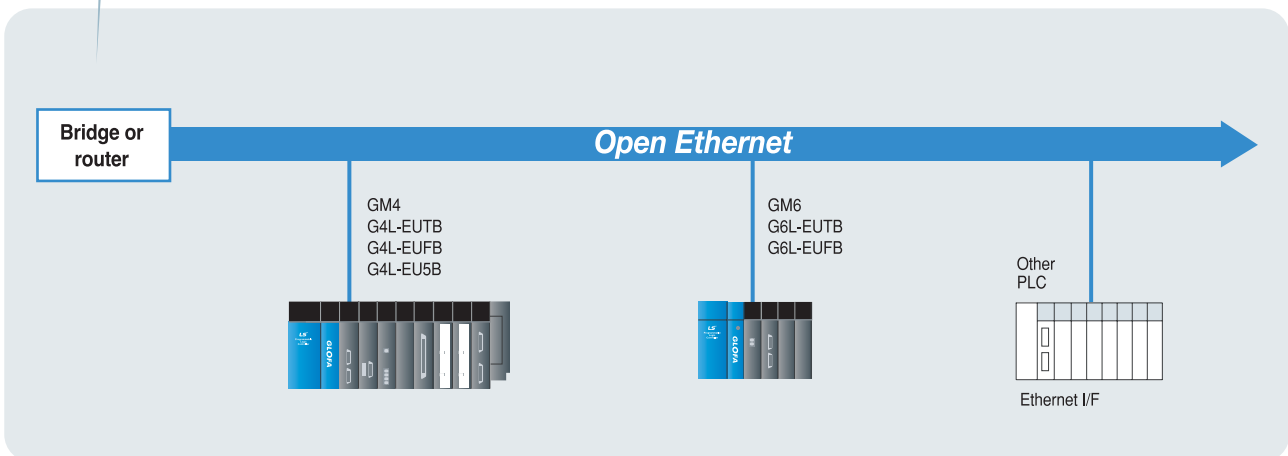
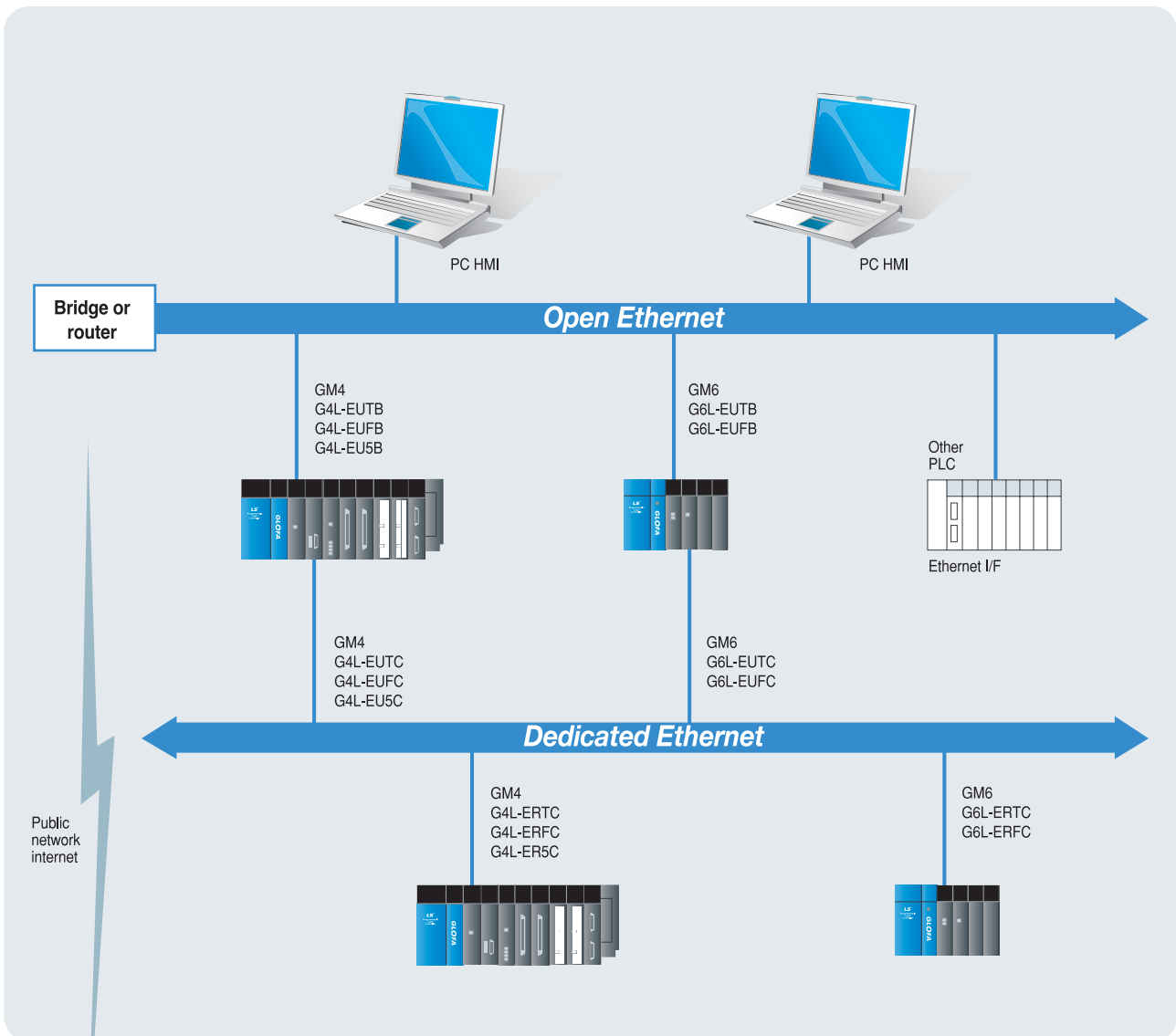

GLOFA-GM Fnet system configuration

Programmable Logic Controller

■ Features

- Transmission speed: 1Mbps, transmission distance: 750m (Electric) *1)
- Communication available up to 5.25km with repeaters (Max.: 6): Electric *1)
- High-speed link capacity: Max. 61,440 points
- Convenient to configure various multi-drop network systems with remote I/O modules (G4L-RBEA/G6L-RBEA)

*1) In case of fiber optical cable, transmission distance is 3km and max. distance is 21km with 6 repeaters.



■ Specifications

Item		Electrical module	Optical module	
Transmission speed		1Mbps		
Encoding type		Manchester Biphase-L		
Transmission distance (per segment)		Max. 750m	Max. 3km	
Max. extension distance		Max. 5.25km (6 repeaters)	Max. 21km (6 EOCs)	
Transmission medium		Twisted pair cable	Optical cable	
Number of nodes		64		
Communication method		Circulated token passing, Address prove method		
High-speed link	Max. data size/station	61,440 points (3840 words)		
	Max. sending data size	30,720 points (1920 words)		
	No. of data block in transmission	64 blocks		
	Data block size in transmission	60 words		
Comm. module	Local	GM4	G4L-FUEA	G4L-FUOA
		GM6	G6L-FUEA	-
		GM7/GM7U	G7L-FUEA *1)	-
	Remote	GM4	G4L-RBEA	-
		GM6	G6L-RBEA	-
Others		<ul style="list-style-type: none"> • Local module is to be set in the I/O slot of the main base. • Remote module is to be set in the CPU slot of the main base. • GM4-CPUA: 2, GM4-CPUB: 4, GM4-CPUC: 8 • GM6: 2 *2) • GM7/GM7U: 1 		

*1) You are not able to use the built-in Cnet or other communication unit when you use G7L-FUEA.

*2) GM6: Up to 2 Fnet modules, GM7/GM7U: Only 1 communication module

*3) G0L-FREB: AC 110-220V, G0L-FREC: DC 24V

Fieldbus active coupler (G0L-FACA)	
Transmission speed	1Mbps
Cable	Optical cable
Transmission distance	3km
Function of signal regeneration	Regenerating, Reshaping function
On reception of abnormal data	Error data transmission
Frame error check	CRC 16
Max.number of coupling station	8
Power supply	AC110V/220V, DC24V
Coupling optic card	Rack type (Branch off/ select the number of stations)

Fieldbus repeater (G0L-FREB, FREC) *3)	
Transmission speed	1Mbps
Cable	Shielded twisted pair cable
Max. extension distance	750m per module
Max. number of repeaters	6 units between stations
Max. distance	5.25km between stations (when 6 repeaters used)
On reception of abnormal data	Error data transmission
Frame error check	CRC 16

Fieldbus electric/optical converter (G0L-FOEA)	
Transmission speed	1Mbps
Cable	Optical cable, Shielded twisted pair cable
Max. transmission distance	3km
Function of signal regeneration	Regenerating, Reshaping
On reception of abnormal data	Error data transmission
Frame error check	CRC 16

■ Network cable

Item	Specifications	Maker
Shielded twisted pair cable	LIREV-AMESB 2 × 1mm, 18 AWG	LS CABLE CO., LTD
	LIREV-AMESB 2 × 0.64mm, 22 AWG	
Optical cable	Y220909, Multi-mode, ST type	LS CABLE CO., LTD
	OJC-DP-MM-XX-ST-ST (XX = Number in meter), Multi-mode, ST type	LS CABLE CO., LTD
Terminal resistance	110 Ω, 1/2 Watt	-

* The above cables are used in development and performance test.

And we can't guarantee system performance as is shown in user's manual, if you use other cables.

GLOFA-GM Fnet system configuration

Programmable Logic Controller

System configuration

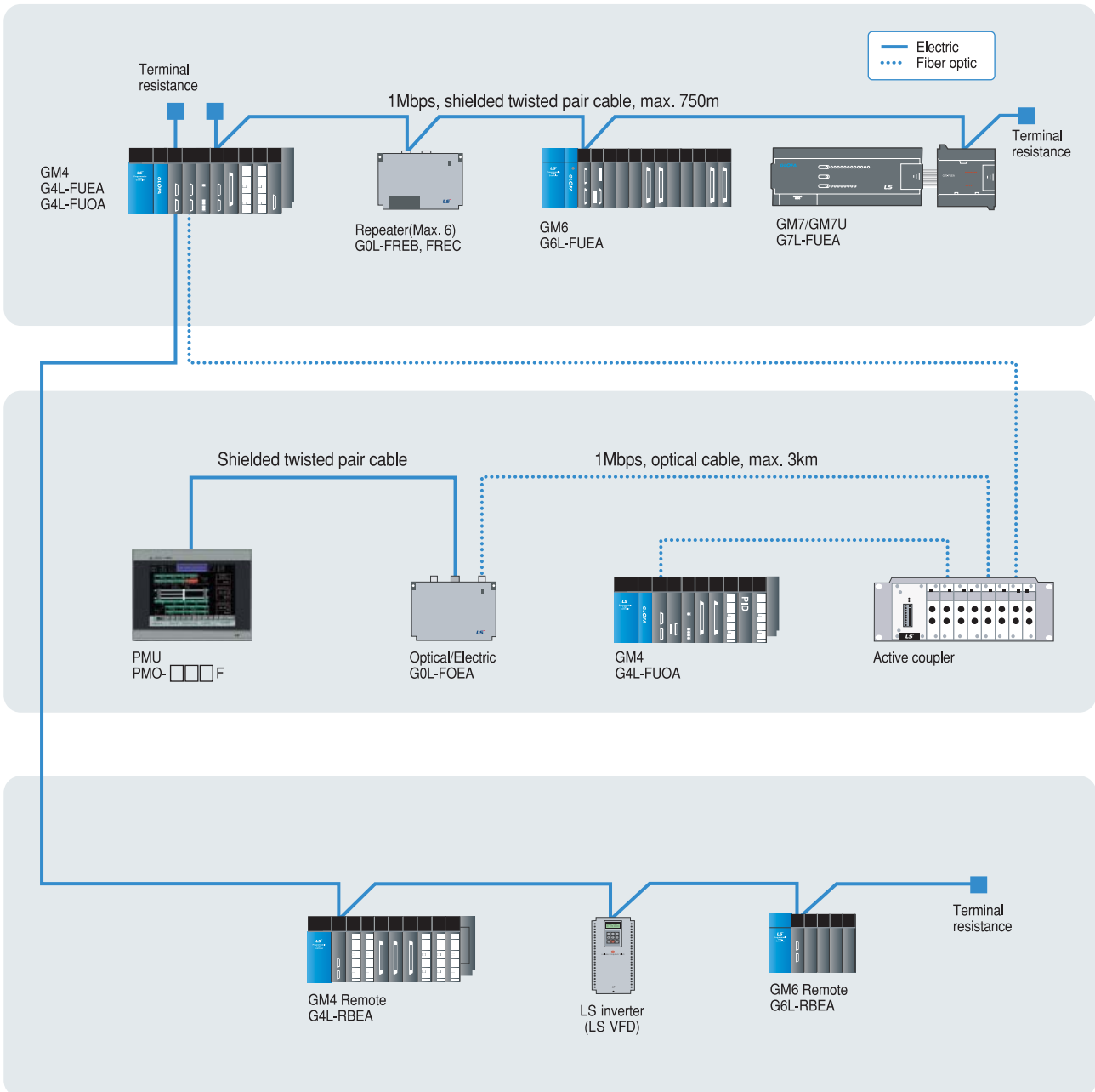

Fnet cable connection

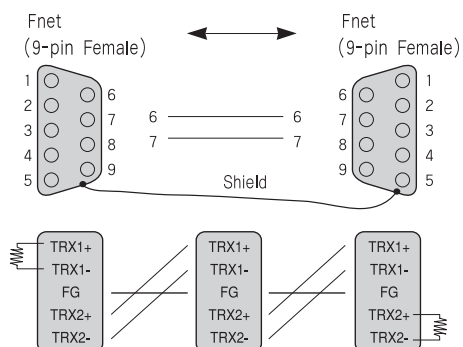

Terminal resistance

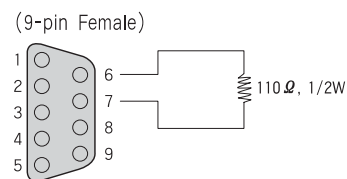

GLOFA-GM Cnet (Computer link system)

Programmable Logic Controller

■ Features

- Various protocol communication thanks to Frame Editor and command
- Easy to make a communication program
- GMWIN connection via phone line using an external modem connection
- Long-distance communication via phone line using a dedicated line modem connection
- Up to 32 stations connectable: Multi-drop service of LSIS dedicated protocol
- RS-232C/RS-422 communication port (Interlocking/Standalone mode)
- Various communication speed setting (300~76,800bps) ^{*1)}
- Parameter setting in Frame Editor
- Full duplex and half duplex support
- GM4-CPUC: 8, GM4-CPUA/B: 4
- GM6: 4
- GM7/GM7U: Only 1 communication module
- Remote operating mode change in online mode
- Easy interface with other PLCs due to AB DF1/MODBUS communication driver support (Slave)
- Easy upgrade using flash memory: Cnet version 2.0 or later



■ Operation mode

Operation mode	Remark
GMWIN mode	Program download, upload by GMWIN protocol (RS-232C)
Dedicated protocol	Data communication using LSIS dedicated protocol
User-defined protocol	Data communication using user-defined frame and command
Test mode	Self-diagnosis (except GM7/GM7U)

■ Specifications

Item		G4L-CUEA	G6L-CUEB	G6L-CUEC	G7L-CUEB	G7L-CUEC
Interface		RS-232C, RS-422/485	RS-232C	RS-422/485	RS-232C	RS-422/485
Comm. mode	Dedicated	1:1 or 1:N communication using LSIS dedicated mode				
	GMWIN	Program download, upload and remote control using GMWIN protocol (RS-232C, 1:1)				
	User-defined	Communication using user-defined protocol by Frame Editor (Interface with other PLCs)				
Data form	Start bit	1 ^{*2)}				
	Data bit	7 or 8 ^{*2)}				
	Stop bit	1 ^{*2)} or 2				
	Parity bit	Even / odd / none				
Channel selection By mode switch		-				
Synchronization		Asynchronous				
Transmission speed		300/600/1,200/2,400/4,800/9,600/19,200/38,400/76,800 ^{*1)}			1,200~57,600	
Network configuration		1:1, 1:N, N:M available (N≤31)	1:1	1:1, 1:N	1:1	1:1, 1:N
Modem communication		Available through RS-232C				
Transmission	RS-232C	15m (Extendible using a modem)	15m	-	15m	-
	RS-422/485	500m	-	500m	-	500m
Max. number of installation		GM4C: 8, GM4A/B: 4	4		1 ^{*3)}	
Diagnostic function		Loop-back test mode				
Current consumption (DC 5V)		160mA			100mA	

^{*1)} Default value

^{*2)} RS-232C: 300~38,400bps, RS-422/485: 300~76,800bps, In case of MODBUS communication, baud rate is 2,400~38,400bps

^{*3)} If you use G7L-CUEB or G7L-CUEC, which is not available to use in G7M-DR10A(DS) or G7M-DT10A, you are not able to use built-in Cnet or any other communication module.

GLOFA-GM Cnet (Computer link) system configuration

■ Communication with RS-422/485 devices

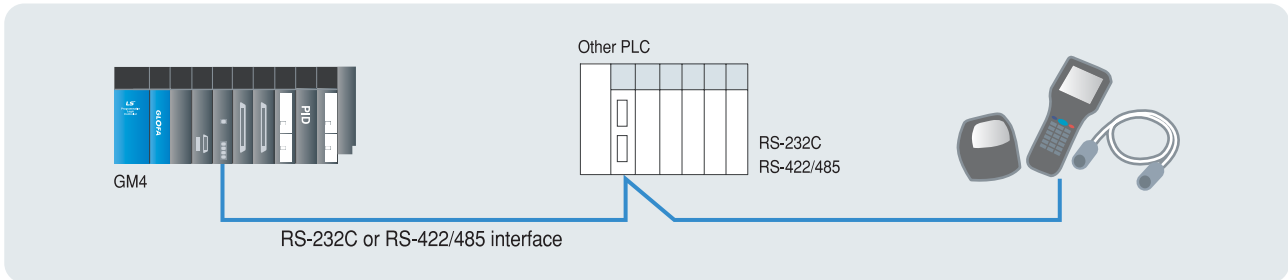

■ 1:1 and N:M connection (dedicated + user-defined)

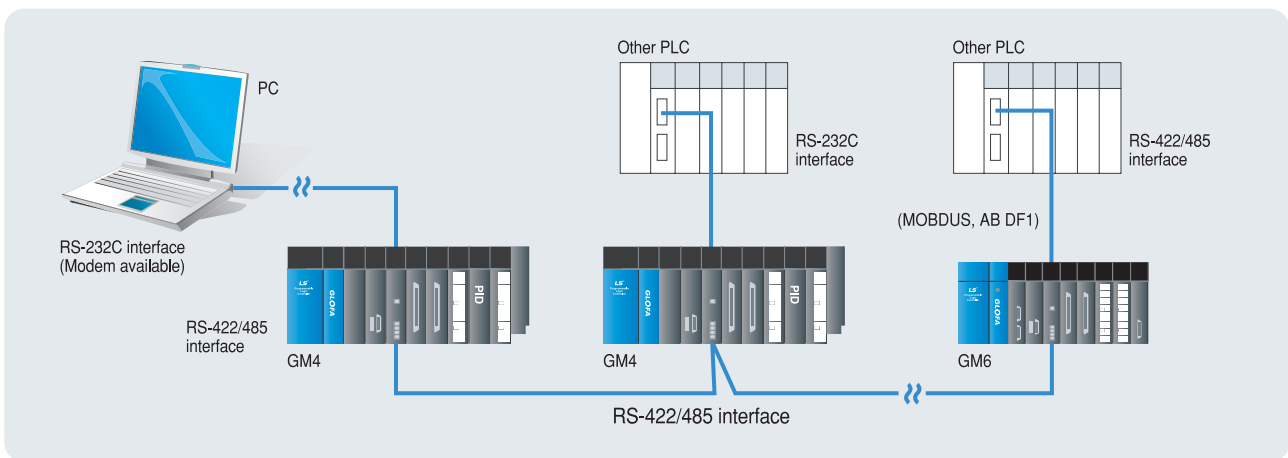

■ MODBUS

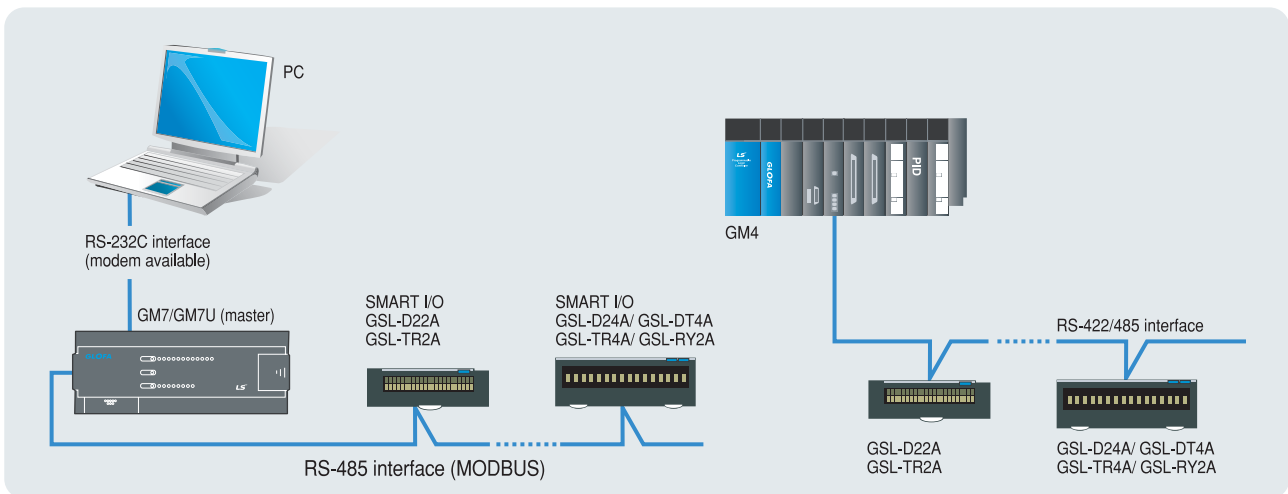

■ Cnet cable connection (RS-232C)

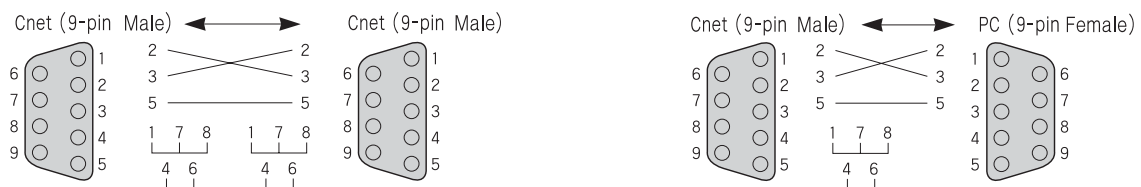

GLOFA-GM Dnet (DeviceNet system)

Programmable Logic Controller

■ Features

- Real time control of various I/O devices in network system
- Max. 63 slave modules control with one master module
- Flexibility in network configuration: Multi-drop and T branch connection
- Connectable to other master module and various slave modules
 - Communication with other slave modules as master
 - Communication with other master module as slave (Mode change by mode switch in master module)
- GM4-CPUC: 8, GM4-CPUB: 4, GM4-CPUA: 2
- GM6: 2
- GM7/GM7U: 1 slave module
- Master/slave communication as predefined master/slave connection communication using scan list enabling high-speed link without other configuration tool



■ Specifications

Item	G4L-DUEA	G6L-DUEA	G7L-DBEA
Module type	Master/Slave (setting by dip switch)		Slave
Protocol	CAN		
Transmission distance and speed *1)	Communication speed	Max. network length (Drop cable)	Max. drop cable length
	500kbps	100m	6m or less
	250kbps	250m	6m or less
	125kbps	500m	6m or less
Max. number of stations	64		
Cable	DeviceNet cable: 5 wires (Signal: 2 wires, power: 2 wires, shield: 1 wire)		
Bus type	Multi slave / Multi casting		
	1:1 (Peer-to-peer type)		
Max. node number	Poll, Strobe, COS/Cyclic type *2)		
System features	Max. 64 MAC ID (Max. 2,048 points)		
Diagnostic function	Available to insert/remove a node when power is on		
Current consumption (DC5V)	285mA	230mA	250mA

*1) In case of thin cable, the max. distance is within 100m regardless of transmission speed.

*2) The type of Strobe, COS/Cyclic on bus type will be served later.

* Maximum transmission distance when thick and thin cables coexist.

The table below lists both the maximum transmission distance when thick and thin cables coexist.

Communication speed	Maximum transmission distance of trunk line when thick and thin cables coexist
125kbps	Thick cable length + 5 × thin cable length ≤ 500m
250kbps	Thick cable length + 2.5 × thin cable length ≤ 250m
500kbps	Thick cable length + thin cable length ≤ 100m

GLOFA-GM Dnet system configuration

Programmable Logic Controller

System configuration

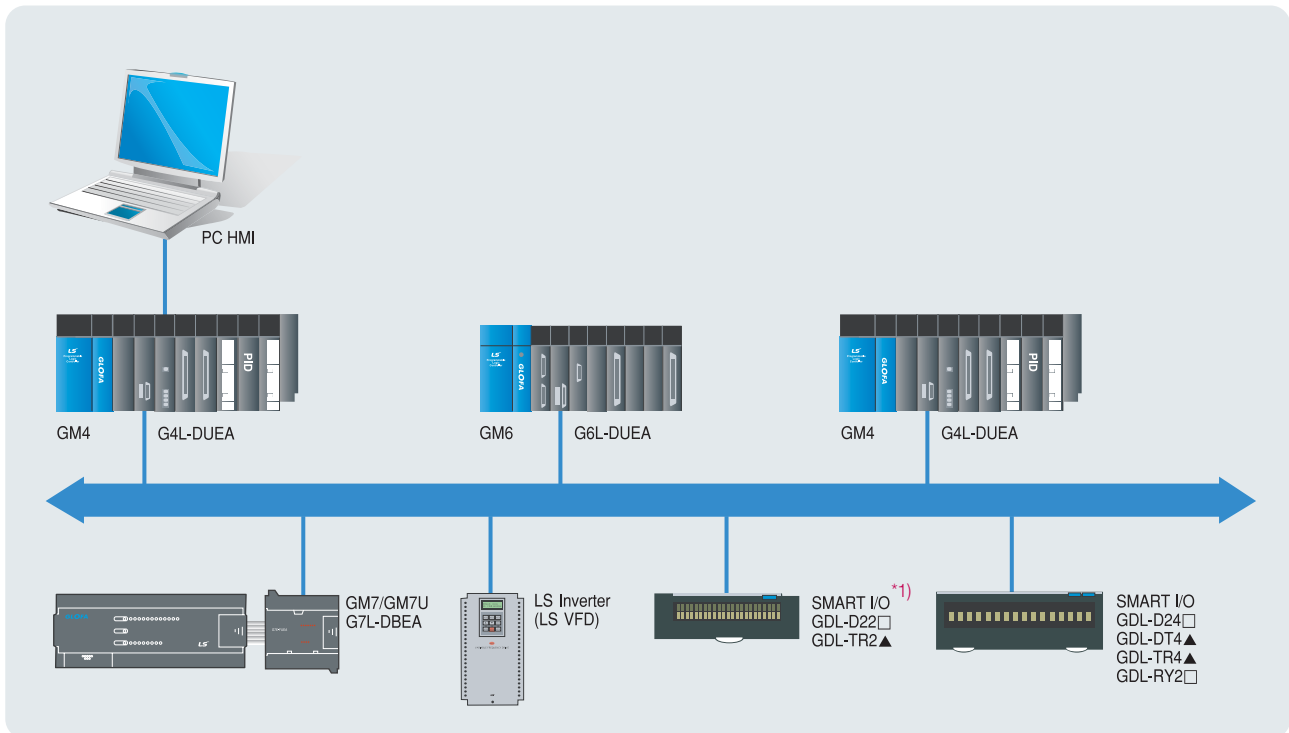

■ System configuration with other products

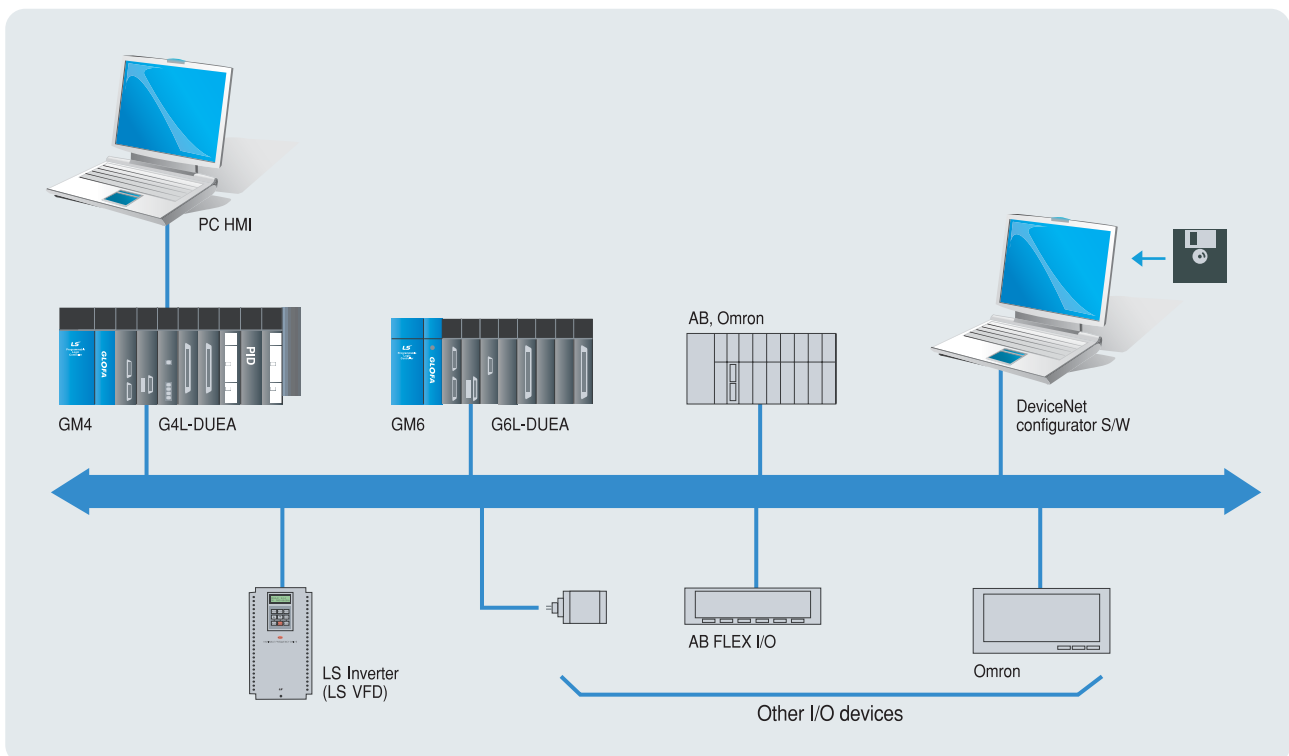

*1) Refer to P42, please.

GLOFA-GM Pnet (Profibus-DP system)

Programmable Logic Controller

■ Features

- Profibus-DP (Decentralized periphery)
- Low cost network appropriate to field level
- Proper to communicate among a master automation device and distributed slave I/O devices
- Master slave network
- Fast slave communication omitting application layer
- Based on RS-485 communication as transmission medium
- Communication speed: 9.6kbps~12Mbps
- Communication distance: 100~1,200m
- Max. 126 stations (32 stations/segment) support
- Network setup using Sycon (Configuration tool)
- Transmission data of master: 1K~7K
- Communication using high-speed link parameter



■ Specifications

Item	G4/6L-PUEA	G4/6L-PUEB	G7L-PBEA	Remark
Module type	Master		Slave	Class 1
Network	Profibus-DP			
Protocol	EN 50170/DIN 19245			
Interface	RS-485 (Electric)			
Medium access	Token passing & poll		Poll	
Topology	Bus			
Modulation	NRZ			Asynchronous
Cable	Shielded twisted pair cable			
Transmission distance	1,200m (9.6kbps~187kbps)			
	400m (500kbps)			
	200m (1.5Mbps)			
	100m (3M~12Mbps)			
Max. number of slave/network	126			
Max. number of slave/segment	32			
Dual port memory size	1K	7K	128 bytes	
Max. I/O data	In: 512 bytes	In: 3584 bytes	In: 64 bytes	
	Out: 512 bytes	Out: 3584 bytes	Out: 64 bytes	
Communication parameter setting	High-speed link parameter in GMWIN		GMWIN	
Configuration tool	Sycon-PB			
Configuration port	RS-232C Configuration port support		-	
Current consumption (DC 5V)	560/520mA	670/700mA	350mA	

GLOFA-GM Pnet system configuration

Programmable Logic Controller

System configuration

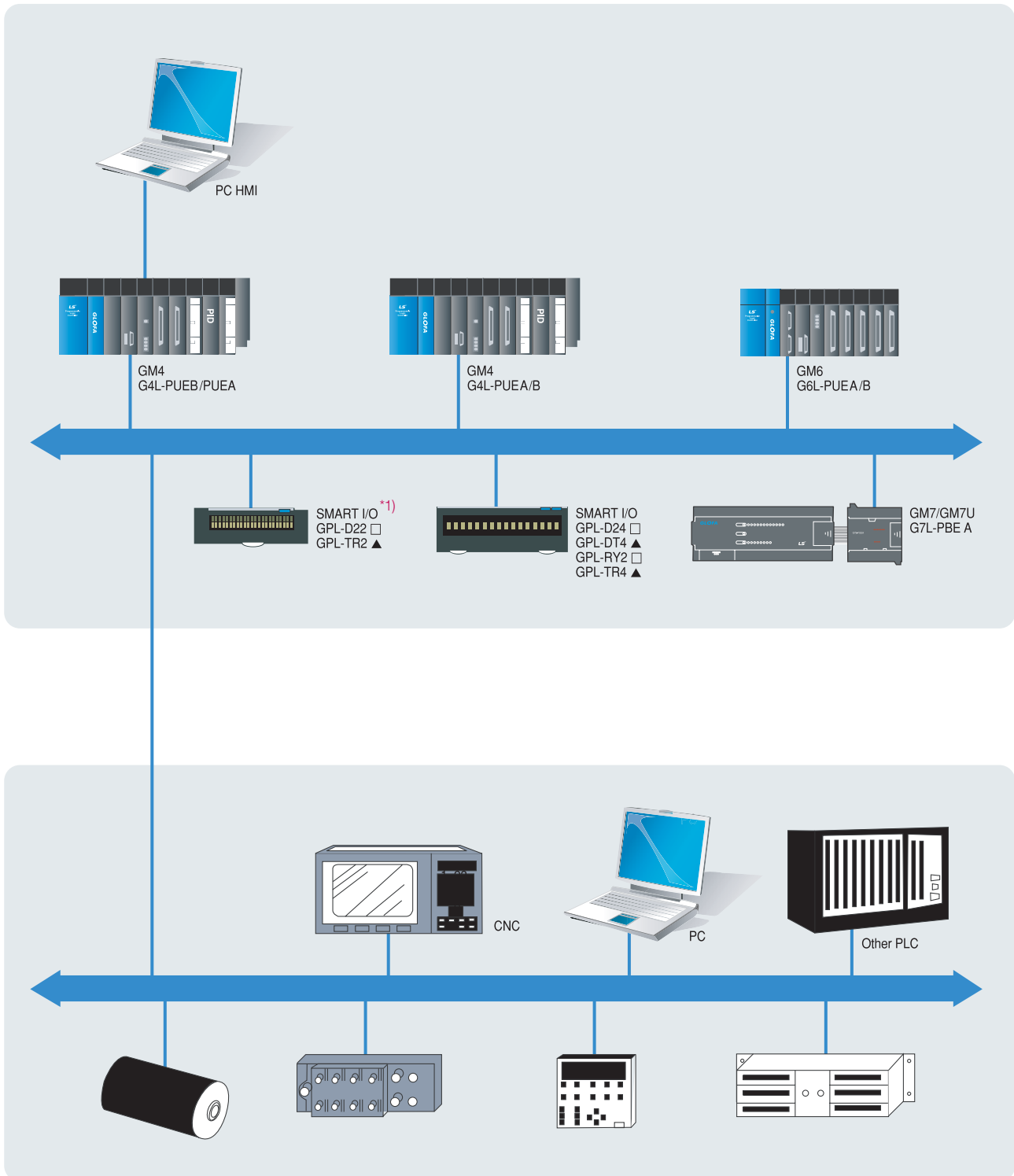

*1) Refer to P42, please.

SMART I/O

Programmable Logic Controller

■ Features

- Reduction in the amount of wiring
- Real-time control of distributed I/O devices
- Rnet, Profibus-DP, DeviceNet, Modbus (RS-422/485) support
- Various I/O modules (DT, TR)
 - A: Sink (NPN), fixed terminal block, 0.1A (Rated load current)
 - B: Source (PNP), fixed terminal block, 0.5A (Rated load current)
 - C: Source (PNP), removable terminal block, 0.5A (Rated load current)
 - A1: Sink (NPN), fixed terminal block, 0.5A (Rated load current)
 - C1: Sink (NPN), removable terminal block, 0.5A (Rated load current)



■ Specifications

Item	Input		Output			Mixed Input/output	
	DC (Sink/Source)		TR (Sink)		Relay	DC (Sink/source)	TR (Sink)
Point	16	32	16	32	16	16	16
Rated input (Load voltage)	DC 24V		DC 24V		DC 24V, AC 110V/220V		
Rated input current *1) (Load current)	7mA		0.1A/2A		2A/5A		
Response time	Off → On	Under 3ms	Under 0.5ms		Under 10ms		
	On → Off	Under 3ms	Under 1ms		Under 10ms		
Common (Point/COM)	16/COM		16/COM		8/COM		
Supporting network & part number	Rnet	GRL-D22A	GRL-D24A	GRL-TR2A	GRL-TR4A	GRL-RY2A	
	Profibus-DP	GPL-D22□*2)	GPL-D24□	GPL-TR2▲*3)	GPL-TR4▲	GPL-RY2□	
	DeviceNet	GDL-D22□	GDL-D24□	GDL-TR2▲	GDL-TR4▲	GDL-RY2□	
	Modbus	GSL-D22A	GSL-D24A	GSL-TR2A	GSL-TR4A	GSL-RY2A	
						GRL-DT4A	
						GPL-DT4▲	
						GDL-DT4▲	
						GSL-DT4A	

*1) It is for A type. For other types, refer to Features.

*2) □: A, C (A: Fixed terminal block, B: Removable terminal block)

*3) ▲: A, A1, B, C, C1

■ Field network support

Item	Rnet (LS SMART I/O)	Profibus-DP	DeviceNet	Modbus
Protocol	LSIS Dedicated Rnet protocol (Fnet for remote)	Profibus-DP (RS-485/EN50170)	DeviceNet (CAN)	Modbus (RS422/485) *1)
Transmission speed	1Mbps	9.6kbps~12Mbps	125/250/500kbps	2.4kbps~38.4kbps
Transmission distance	750m/segment	100m~1.2km	500/250/125m(Thin cable: 100m)	500m
Topology	Bus token	Bus	Trunk & drop	Bus
Transmission method	Token pass & Broadcast	Token pass & Master/Slave (Poll)	CSMA/NBA *2)	Master/Slave (Poll)
Max. number of stations	64/segment (In 32/Out 32)	32/segment	64	32
Link capacity	2,048 pt./master (64 sta. x 32 pt.)	1K*/master: -PUEA 7K*/master: -PUEB	2,048 pt./master	64 pt./station

*1) RS-485 is available at Modbus SMART I/O version 1.1 or later.

*2) Carrier Sense Multiple Access with Non-destructive Bitwise Arbitration.

■ Dimensions

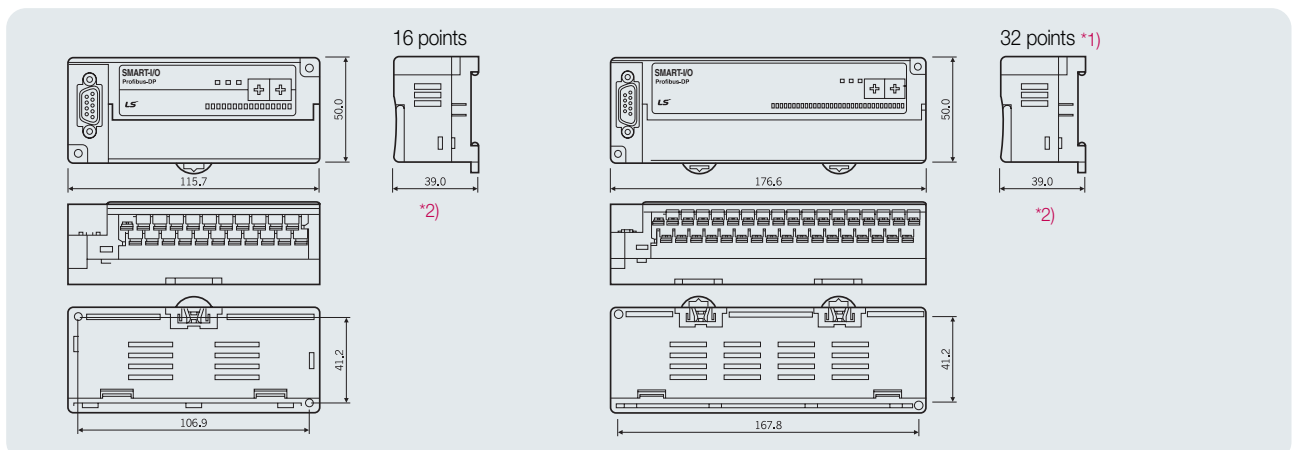

*1) The dimensions of relay type SMART I/O is equivalent to those of 32-point SMART I/O.

*2) C, C1 type: 47.5

SMART I/O system configuration

Programmable Logic Controller

■ SMART I/O Rnet system

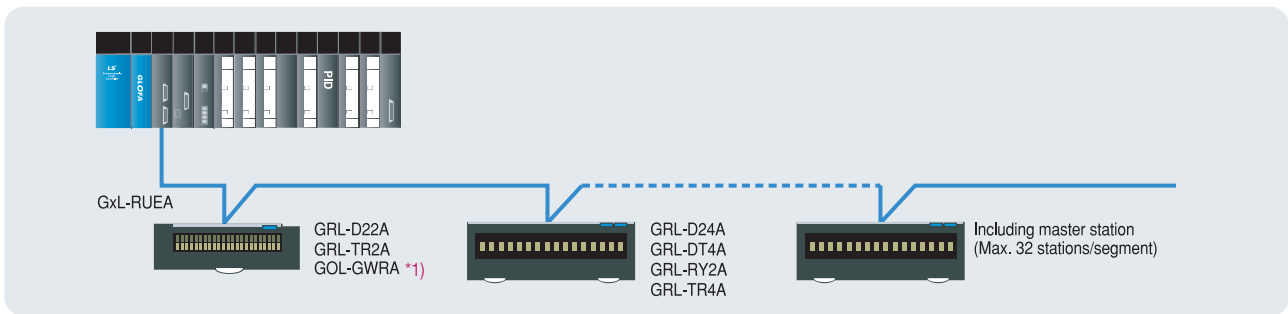

*1) GOL-GWRA: Rnet remote connection module

■ SMART I/O MODBUS system

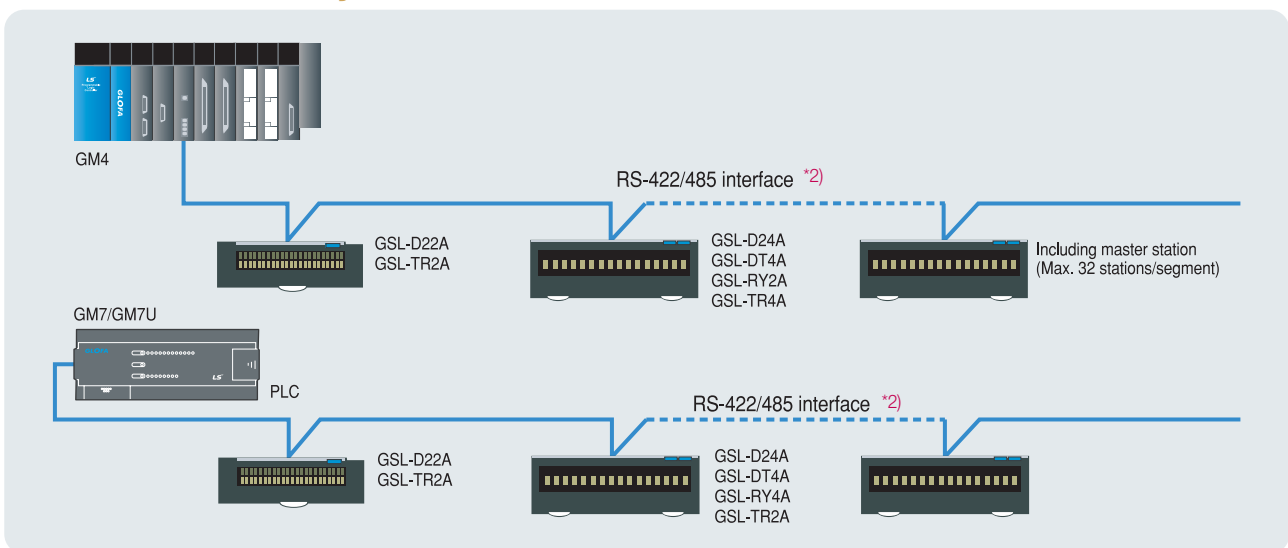

*2) RS-485 is available at SMART I/O version 1.1 or later.

■ SMART I/O Profibus-DP system

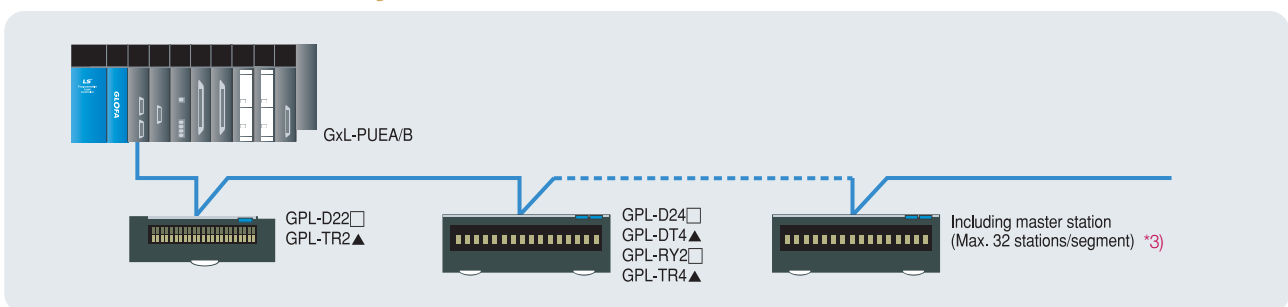

*3) Segment: communication section where a repeater or other master station is not used.

SMART I/O DeviceNet system

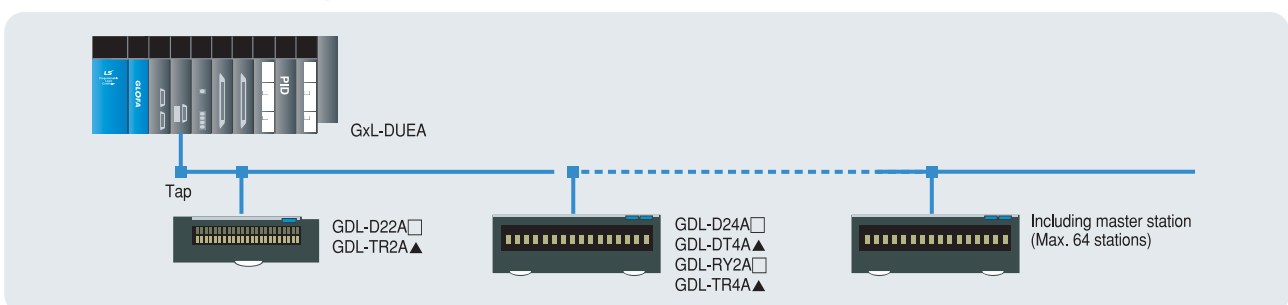

Analog input module (GM4/6)

Programmable Logic Controller

■ Features

- 4-/8-channel analog input per module
- Voltage/Current selection by dip switch/terminal
- Digital range selection (-8,192~8,191 or -192~16,191): G4F-AD2A
- High resolution (1/16,000, 1/4,000)



■ Specifications

Item		G4F-AD2A *1)	G4F-AD3A	G6F-AD2A *2)
Analog input	Voltage	DC -5~+5 DC -10~+10V	DC 1~5V DC 0~10V	DC 1~5V DC 0~10V, -10~+10V
	Current *3)	DC -20~+20mA	DC 4~20mA	DC 4~20mA
	Voltage/Current select	Input terminal connection	Input selection switch	Input terminal connection
	Voltage range select	Input range selection switch	Program	Input range selection switch
Digital output		0~16,000 -8,000~8,000	0~4,000	0~4,000 -2,000~2,000
	Resolution			
Resolution	DC 1~5V	-	1.0mV (1/4,000)	1.0mV (1/4,000)
	DC 0~10V	-	2.5mV (1/4,000)	2.5mV (1/4,000)
	DC -5~5V	0.625mV (1/16,000)	-	-
	DC -10~10V	1.25mV (1/16,000)	-	5mV (1/4,000)
	DC -20~20mA	2.5μA (1/16,000)	-	-
	DC 4~20mA	-	4μA (1/4,000)	4μA (1/4000)
Accuracy		±0.5% (Full scale) ±0.3% at 25°C	±0.5% (Full scale) ±0.3% at 25°C	±0.5% (Full scale) ±0.3% at 25°C
	Max. conversion speed	5ms/Ch	5ms/Ch	5ms/Ch
Max. absolute output	Voltage		±12V	
	Current		±25mA	
Analog input point		4 Channels	8 Channels	4 Channels
Offset/gain		Available	Not available	
Insulation method		Between input terminal and PLC power supply: Photocoupler, Between channels: No insulation		
Current consumption		400mA (5V)	500mA (5V)	40mA (+5V), 50mA (+15V), 20mA (-15V)

*1) You are able to adjust offset and gain value in G4F-AD2A so that you can adjust input range.

*2) If you use analog modules in GM6, you are supposed to use GM6-PAFB or GM6-PDFB for power module.

*3) For current input, connect V and I terminal.

■ A/D conversion characteristics

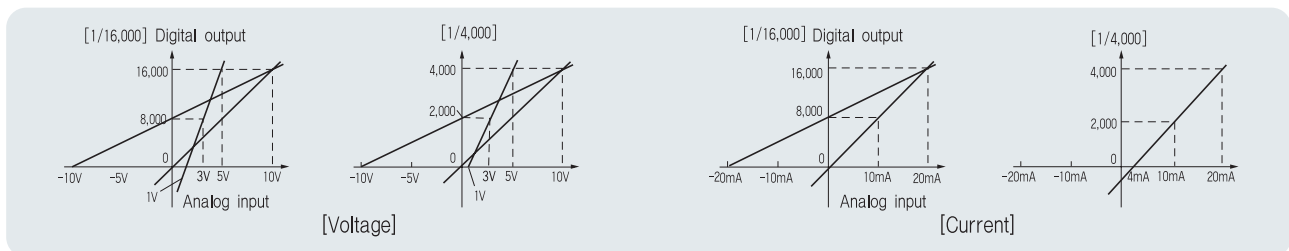

■ Configuration

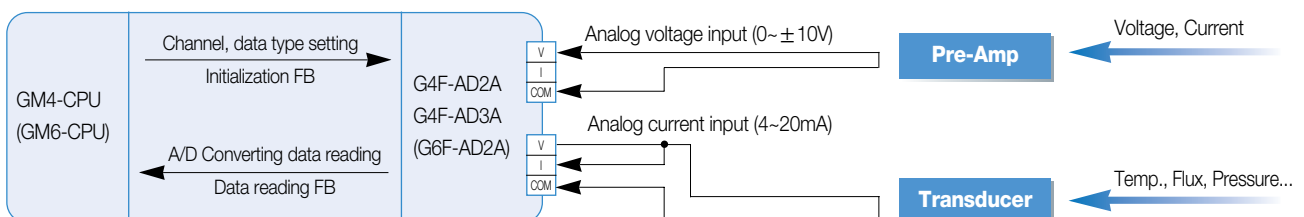

Analog output module (GM4/6)

Programmable Logic Controller

■ Features

- 2-/4-/8-channel analog output per module
- Analog voltage/current output when CPU stops (set in FB)
 - medium, previous, max., min. value: G4F-DA1A
- Various modules according to output types



■ Specifications

Item	G4F-DA1A *1)	G4F-DA2V	G4F-DA3V	G4F-DA2I	G4F-DA3I *2)	G6F-DA2V *3)	G6F-DA2I *3)	
Digital input	-192~16,191 -8,092~8,191	-48~4047						
Analog output	Voltage	DC -10~10V	DC -10~10V		-	-	DC -10~10V	-
	Current	DC 4~20mA	-	-	DC 4~20mA		-	DC 4~20mA
	V/C selection	Output terminal	-	-	-	-	-	-
Resolution	DC -10V~10V	1.25mA (1/16000)	5mV (1/4000)		-	-	5mV (1/4000)	-
	DC 4~20mA	2.5μA (1/6000)	-	-	4μA (1/4000)		-	4μA (1/4000)
Accuracy	±0.3% (Full scale)		±0.5% (Full scale)					
Max. conversion speed	3ms/module	10ms/module	15ms/module	10ms/module	15ms/module	10ms/module		
Max. absolute output	Voltage	DC 15V			-	-	DC 15V	-
	Current	DC 24mA	-	-	DC 24mA		-	DC 24mA
Analog output point	2 Channels	4 Channels	8 Channels	4 Channels	8 Channels	4 Channels		
Insulation	Between input terminal and PLC power supply: Photocoupler, Between channels: No insulation							
External power supply	Voltage	-	-	-	-	DC 21.6~26.4V	-	-
	Current	-	-	-	-	230mA	-	-
Current consumption	450mA (5V)	400mA (5V)	700mA (5V)	680mA (5V)	70mA	5V (40mA) 5V (80mA) -15V (60mA)	5V (40mA) 15V (120mA) -15V (25mA)	

*1) You are able to adjust offset and gain value in G4F-DA1A so that you can adjust output range.

*2) If you use G4F-DA3I, you are supposed to supply external DC 24V for its operation.

*3) If you use analog modules in GM6, you are supposed to use GM6-PAFB or GM6-PDFB for power module.

■ A/D conversion characteristics

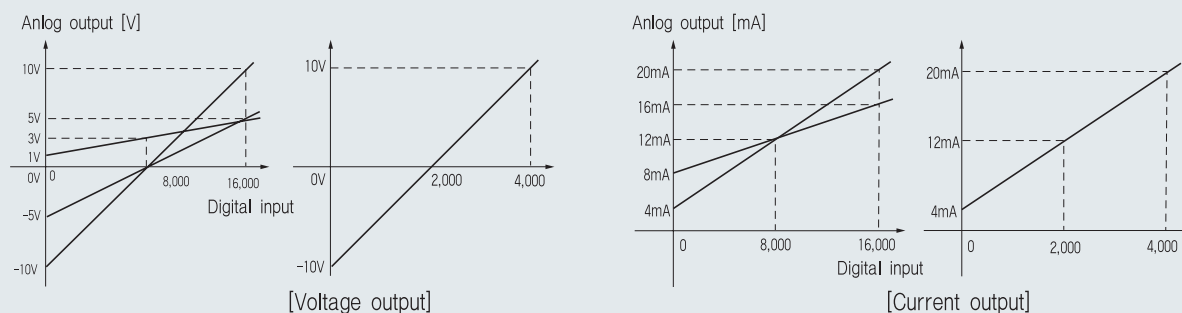

Temperature control module (GM4)

Programmable Logic Controller

■ Features

- Simultaneous control of different processors with one module
- Forward/Reverse control selectable
- Manual output (forced output) available
- Autotuning (P, I, D values are found automatically)
- No additional input/output is needed due to various input/output built-in functions
- Input: RTD (2 types), Thermocouple (7 types), Voltage, Current
- Output: Current, Open collector output of time proportional control
- Cascade function: Interworking control of a processor
- On/Off control available



■ Specifications (G4F-TMCA)

● Input/output specifications

Item		Specifications					
Input	Thermocouple	Type	DIN specification	BS specification	Measuring temperature range (°C)	Measuring voltage range (μV)	
		K	NiCr-Ni	NiCr-NiAl	-200.0~1,300.0	-5,891~52,398	
		J	-	Fe-CuNi	-200.0~1,000.0	-7,890~57,942	
		E	-	NiCr-CuNi	200.0~800.0	-8,824~61,022	
		T	-	Cu-CuNi	-200.0~400.0	-5,603~20,869	
		B	-	PtRh30-PtRh6	400.0~1,800.0	0~20,215	
		R	-	PtRh13-Pt	0.0~1,750.0	0~17,942	
	S	PtRh-Pt	PtRh10-Pt	0.0~1,750.0	786~13,585		
	RTD	Type			Measuring temperature range (°C)	Measuring resistance range (Ω)	
		Pt100			-200.0~600.0	18.49~313.59	
Analog	Input range	I	DC 4~20mA				
		V	DC 1~5V				
	Max. resolution	I	2μA (1/8,000)				
		V	0.25mV (1/8,000)				
	Absolute Max. input		Voltage: 15V, Current: 25mA				
	Insulation method		Between input terminal and PLC power supply: Photocoupler, Between channels: No insulation				
	Number of loops		2 (Simultaneous 2 loops, including thermocouple, RTD, V and I input, available to use)				
	Digital output		PV (Present value) 1. Thermocouple, RTD: Temperature detection value [Measuring temperature value × 10 (displaying decimal one point)] 2. Voltage, Current Input: 0~8,000				
	Output	Analog	Current output	DC 4~20mA			
			Max. resolution	4μA (1/4,000)			
Absolute max. output			Voltage: 15V, Current: 25mA				
Transistor output		Max. pulse output		1ms (1/4000: 1ms unit)			
		Output control period		1~100sec (1/1,000)			
		Rated load voltage		DC 24V			
		Load voltage range for usage		DC 20.4~26.4V			
		Max. load current		70mA			
		Max. voltage drop (ON)		DC 1.5V (70mA)			
		Response time	Off → On		1ms		
On → Off			1ms				
Common method		2 points/COM					
Insulation method		Between output terminal and PLC power supply: Photocoupler, Between loops: No insulation					
Number of loops		2 (Simultaneous 2 loops, including V and transistor output, available to use)					
Digital input		MV (Manipulated value): Current, Transistor output: 0~4,000					

● PID specifications

Item	Specifications	
Setting range of PID values	P	1~10,000 [0.01~100.00 (%)] (Proportion control when I/D values are 0.0)
	I	1~36,000 [0.0~3600.0 (sec)] (Integration control disabled if set 0.0)
	D	1~36,000 [0.0~3600.0 (sec)] (Differentiation control disabled if set 0.0)
SV and PV range	1. Thermocouple, RTD: Temperature detection value [Measuring temperature value × 10 (Displaying decimal one point)] 2. Voltage, Current input: 0~8,000	
MV range	0~4,000	
MMV range	0~4,000	
No. of control loops	2 loops	
Control period	200ms	
Processing type	Measured-value derivative (pre-derivative) type	

● Common specifications

Item	Specifications	
External power supply	Voltage range	DC 20.4~26.4V
	Current consumption	90mA
Internal current consumption	354mA	
Weight	370g	

Thermocouple module (GM4/6)

Programmable Logic Controller

■ Features

- 5 thermocouple types available (KS, JIS, ANSI, DIN, BS)
- Automatic reference junction compensation
- Burn-out detection in every channel



■ Specifications

Item	G4F-TC2A		G6F-TC2A *1)		
Thermocouple	K, J, E, T, B, R, S (Setting per channel available)				
TC input point	4 Channels				
Digital input	Digital conversion value: 0~16,000				
	Temperature conversion value: (Measuring temperature range of thermocouple) × 10				
Temperature input range	Thermocouple type	DIN specification	BS specification	Measuring temperature range (°C)	Measuring voltage range (μV)
	K	NiCr-Ni	NiCr-NiAl	-200.0~1200.0	-5,891~48,828
	J	-	Fe-CuNi	-200.0~800.0	-7,890~45,498
	E	-	NiCr-CuNi	-150.0~600.0	-7,279~45,085
	T	-	Cu-CuNi	-200.0~400.0	-5,603~20,869
	B	-	PtRh30-PtRh6	400.0~1,800.0	786~13,585
	R	-	PtRh13-Pt	0.0~1,750.0	0~21,006
S	PtRh-Pt	PtRh10-Pt	0.0~1,750.0	0~18,612	
Reference junction compensation	Automatic compensation				
Max. conversion speed	50ms/Channel				
Burn-out detection	Every channel				
Accuracy	± [Full scale × 0.3% + 1°C (Reference junction compensation error)]				
Current consumption	450mA		5V/100mA, 15V/40mA, -15V/20m		

*1) If you use an analog module (G6F-TC2A) in GM6, you are supposed to do GM6-PAFB or GM6-PDFB for its operation.

RTD* module (GM4)

■ Features

- Burn-out detection in every channel



■ Specifications

Item	G4F-RD2A
Connectable RTD	Pt100 (JIS C1640-1989, DIN 43760-1980)
	JPt100 (KS C1603-1991, JIS C1604-1981)
Input channel	4 Channels
Digital output	Digital conversion value: 0~16,000, Detected temperature conversion value: -2,000~6,000
Temperature input range	Pt100: -200.0~600.0°C (18.48~313.59 ℚ)
	JPt100: -200.0~600.0°C (17.14~317.28 ℚ)
Burn-out detection	Every channel
Max. conversion speed	50ms/Channel (Full scale)
Accuracy	±0.5% (Full scale)
Current consumption	420mA

* RTD: Resistance thermometer device.

PID control module (GM4)

Programmable Logic Controller

■ Features

- PID control: Max. 16 loops
- Forward/Reverse control selectable
- Manually manipulated value output available
- Measured-value derivative type
- LED display for an error and operation condition of each loop
- Autotuning function

■ Specifications

Item	G4F-PIDB	
PID control loops	16	
PID constant	P value (P)	0.01~100.00 (%)
	I value (I)	0.0~3,000.0 (sec)
	D value (D)	0.0~3,000.0 (sec)
Setting range (SV)	0~16,000	
Input range (PV)	0~16,000	
Output range (MV)	0~16,000	
Manually manipulated value	0~16,000	
LED function	Run/Stop	LEDs of corresponding loops ON if they run
	Error	LED flickering
Control action	Forward/Reverse action control available	
Control cycle	0.01~99.99s	
Processing type	Measured-value derivative (Pre-derivative) type	
Internal current consumption (DC 5V)	600mA	
Output point/COM	16 points/COM	



■ PID control operation

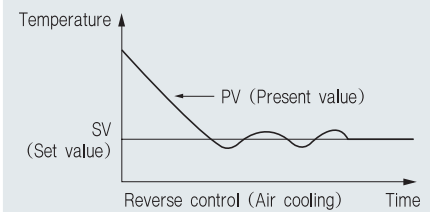
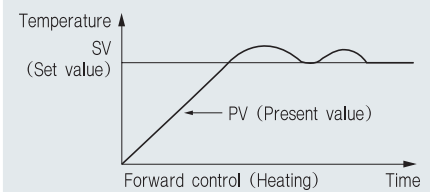

Analog timer module (GM4)

■ Features

- Setting and adjusting time (Highly precise range) available
- Max. 8 points of Analog Timer per module applicable
- Various range of setting time (0.1~600sec)
- Easy timer setting with switch manipulation
- LED display for timer operation status
- Timer setting available in run mode

■ Specifications

Item	G4F-AT3A	
Point	8 points	
Timer setting value range (sec)	0.1~1.0, 1~10, 10~60, 60~600 Setting can be done for each point	
Setting method	Set the operation mode selection SW to TEST side	
Backup method	Setting by adjustment volume	
Accuracy	±2.0% (Full-scale)	
LED function	Operation LED	8 points
	Contact LED	8 points
Operation	CR analog type (On-delay) operation	
Internal current consumption (DC 5V)	200mA	



Positioning module (APM): (GM4/6)

Programmable Logic Controller

■ Features

- Highly reliable position control with LSIS ASIC-embedded processor
- Enhanced control with fast control processing speed
- High-speed motor control (Max. pulse output: 1Mbps)
- Arc/linear interpolation, separate/synchronous operation
- Trapezoidal & S-curve acceleration/deceleration function
- Easy and quick to control through external input (JOG operation included)
- Encoder input support
- Self-diagnosis, monitoring and test by APM
 - Diagnosis for I/O signal line
 - Easy to set position control parameters
 - Monitoring/tracking/simulation
 - Information and solution for each error provided
 - Available to edit operation parameter data in EXCEL



■ Specifications

Item		Open collector type			Line drive type		
Number of axes		1	2	3	1	2	3
CPU type	GM4	G4F-PP1O	G4F-PP2O	G4F-PP3O	G4F-PP1D	G4F-PP2D	G4F-PP3D
	GM6	G6F-PP1O	G6F-PP2O	G6F-PP3O	G6F-PP1D	G6F-PP2D	G6F-PP3D
Output signal		Pulse					
Interpolation		2- and 3-axis linear interpolation/2-axis arc interpolation					
Speed (Position) control		Yes					
Positioning data		400/axis					
Setting unit		mm, inch, degree, pulse					
Data backup		Flash memory					
Position address range		-2,147,483,648~2,147,483,647					
Positioning speed range*1)		0.01~20,000,000.00 (mm/min)					
		0.001~2,000,000.00 (inch/min)					
		0.001~2,000,000.00 (degree/min)					
Max. output pulse		1~200,000 (pulse/s)			1~1,000,000 (pulse/s)		
Output frequency/distance		200kbps			1Mbps		
Output frequency/distance		200kbps/2m			1Mbps/10m		
Acceleration/Deceleration pattern and time		Trapezoidal & S-curve acceleration/deceleration 1~65,535ms					
Origin point return method		Approximate origin point (DOG (ON)/HOME, DOG (OFF)/HOME, DOG), Upper/Lower limit					
High-speed return to origin		Yes (Floating point)					
Manual operation		JOG/MPG*2) /Inching operation					
M code		1~65,535					
Synchronous operation		Yes					
Backlash compensation		Yes					
Others		Speed change during operation					
		Position address change during operation					
		Speed/position switching					
		Zone output*2): 3 ranges settings available (GM4 only)					
Current consumption (DC 5V)		Simultaneous operation					
		730mA	760mA	770mA	700mA	720mA	740mA
		480mA	490mA	500mA	630mA	750mA	840mA











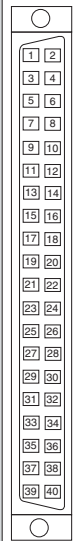



*1) In case of mm, inch or degree, speed limit varies according to pulse per rotation, transfer distance per rotation and unit multiplier.

*2) Available at GM4. MPG operation and zone output are not available at GM6.

I/O interface with external equipment

Programmable Logic Controller

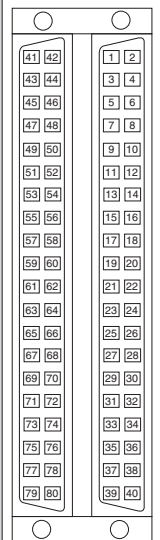
■ Pin layout for (G4F-PP□O, G4F-PP□D)

Pin layout	For	Pin number			Signal name	Signal direction APM - Ext. device	Condition			
		X	Y	Z						
 <p>1 axis</p>	A x i s	21	41	61	FP+	Pulse output (Differential +)	→			
		22	42	62	FP-	Pulse output (Differential -)	→			
		23	43	63	RP+	Pulse sign (Differential +)	→			
		24	44	64	RP-	Pulse sign (Differential -)	→			
		25	45	65	OV+ *	High limit	←			
		26	46	66	OV- *	Low limit	←			
		27	47	67	STOP	External stop signal	←			
		28	48	68	DOG	Approximate origin	←			
		29	49	69	VTP	Speed/Position switching signal	←			
		30	50	70	ECMD command signal	Start	←			
		31	51	71		Skip	←			
		32	52	72		JOG+(Forward)	←			
		33	53	73	DRVIN *	Drive unit ready signal	←			
		34	54	74	DRVIN COM	Drive unit ready signal common	↔			
		35	55	75	HOME +24V	Zero signal (+24V)	←			
		36	56	76	NC	Not used				
		37	57	77	HOME +5V	Zero signal (+5V)	←			
		38	58	78	HOME COM	Zero signal (+24V, +5V) Common	↔			
		39	59	79	NC	Not used				
		40	60	80	NC	Not used				
		 <p>2/3 axes</p>	C o m m o n	1			MPG A+	Manual pulse generator/Encoder A+ Input	←	
				2			MPG A-	Manual pulse generator/Encoder A- Input	←	
				3			MPG B+	Manual pulse generator/Encoder B+ Input	←	
				4			MPG B-	Manual pulse generator/Encoder B- Input	←	
				5			MPG Z+	Encoder Z+ Input	←	
				6			MPG Z-	Encoder Z- Input	←	
				7			CON	External simultaneous start	←	
				8			EMG *	Emergency stop	←	
				9			NC	Not used		
				10			COM	(CON, EMG) Common	↔	
				11			Out 1	Transistor output of Zone 1	→	
				12			Out 2	Transistor output of Zone 2	→	
				13			Out 3	Transistor output of Zone 3	→	
				14			COM	ZONE Common	↔	
				15, 16, 17, 18, 19, 20			NC	Not used		

* High/low limit, drive unit ready signal, emergency stop signal should be connected to DC 24V.

■ Pin layout for (G6F-PP□O, G6F-PP□D)

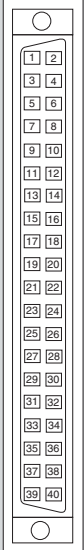
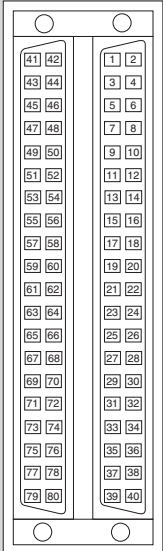
Pin layout	For	Pin number			Signal name	Signal direction APM - Ext. device	Condition				
		X	Y	Z							
 <p>1 axis</p>	A x i s	21A	1B	21B	FP+	Pulse output (Differential +)	→				
		22A	2B	22B	FP-	Pulse output (Differential -)	→				
		23A	3B	23B	RP+	Pulse sign (Differential +)	→				
		24A	4B	24B	RP-	Pulse sign (Differential -)	→				
		25A	5B	25B	OV+ *	High limit	←				
		26A	6B	26B	OV- *	Low limit	←				
		27A	7B	27B	STOP	External stop signal	←				
		28A	8B	28B	DOG	Approximate origin	←				
		29A	9B	29B	VTP	Speed/Position switching signal	←				
		 <p>2/3 axes</p>	C o m m o n	30A	10B	30B	ECMD	External command signal	Start	←	
								Skip	←		
								JOG+(Forward)	←		
				31A	11B	31B	JOG-	JOG reverse operation	←		
				32A	12B	32B	COM	Common (OV+, OV-, STOP, DOG, VTP, ECMD, JOG-)	↔		
				33A	13B	33B	DRVIN *	Drive unit ready signal	←		
				34A	14B	34B	DRVIN COM	Drive unit ready signal common	↔		
				35A	15B	35B	HOME +24V	Zero signal (+24V)	←		
				36A	16B	36B	HOME COM	Zero signal (+24V, +5V) Common	↔		
				37A	17B	37B	HOME +5V	Zero signal (+5V)	←		
		38A	18B	38B	P COM	External 5V, 24V GND (Not used in case of line drive output)	↔				
		39A	19B	39B	5V	External 5V Power input (Not used in case of line drive output)	←				
		40A	20B	40B	24V	External 24V Power input (Not used in case of line drive output)	←				
				1A			MPG A+	Manual pulse generator/Encoder A+ Input	←		
				2A			MPG A-	Manual pulse generator/Encoder A- Input	←		
				3A			MPG B+	Manual pulse generator/Encoder B+ Input	←		
				4A			MPG B-	Manual pulse generator/Encoder B- Input	←		
				5A			NC	Not used			
				6A			NC	Not used			
				7A			CON	External simultaneous start	←		
				8A			EMG *	Emergency stop	←		
				9A			NC	No use			
				10A			COM	(CON, EMG) Common	↔		
		11A, 12A, 13A, 14A, 15A, 16A, 17A, 18A, 19A, 20A			NC	Not used					

* High/low limit, drive unit ready signal, emergency stop signal should be connected to DC 24V.

Example of connection with drivers

Programmable Logic Controller

MR-J2/J2S-□A connection (line drive) G4F-PP1/2/3D

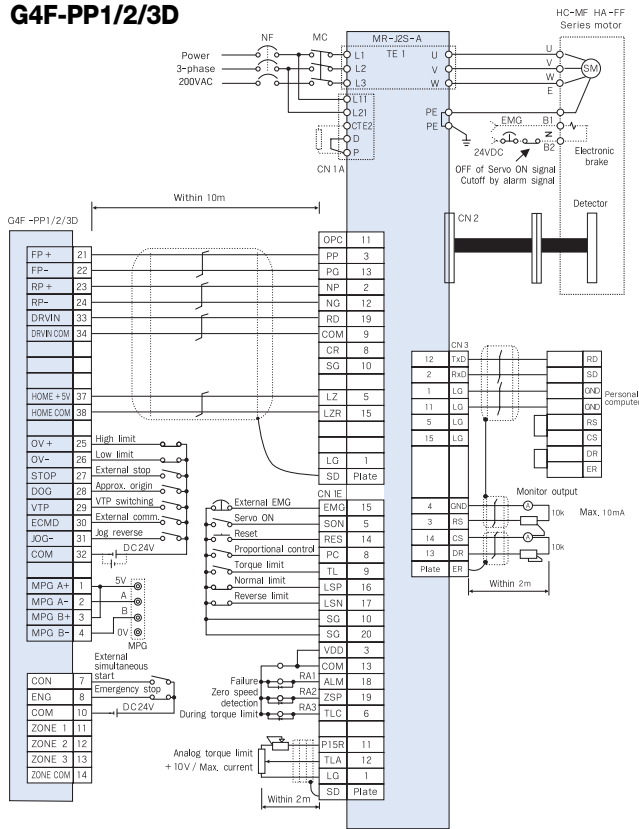

FDA-5000 AC Servo driver connection (open collector) G4F-PP1/2/3O

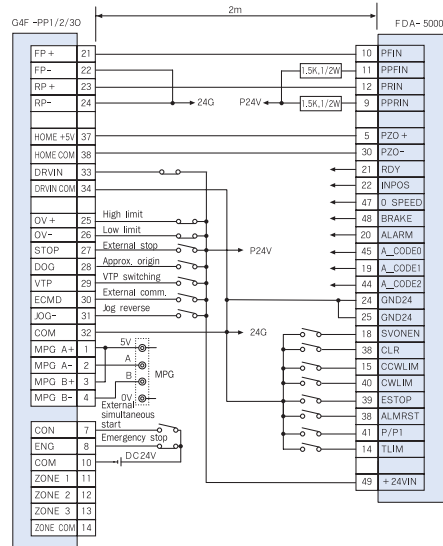

MR-J2/J2S-□A connection (line drive) G6F-PP1/2/3D

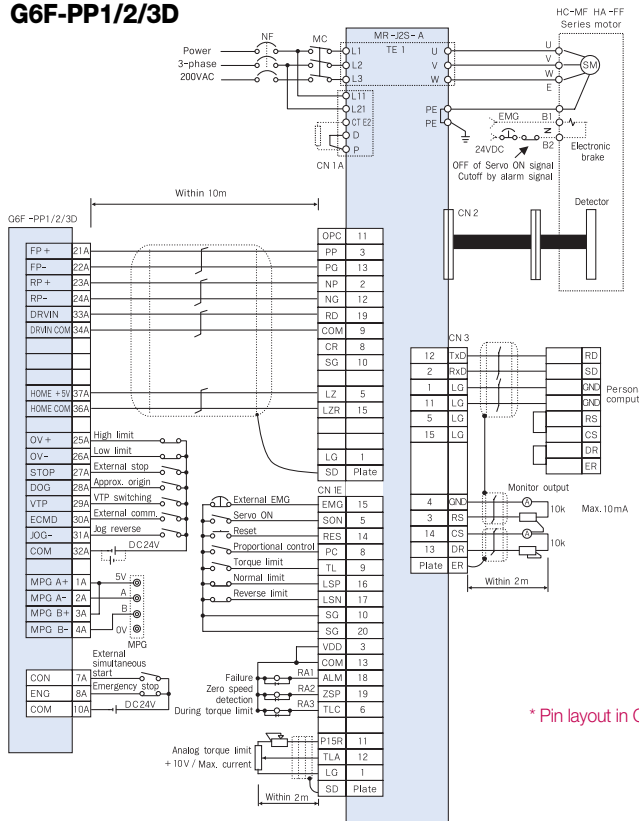

FDA-5000 AC Servo driver connection (line drive) G4F-PP1/2/3D

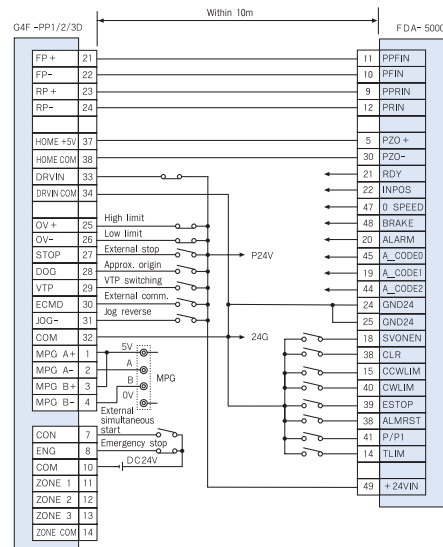

* Pin layout in G4F-PP□D(O) and G6F-PP□D(O) is different.

High speed counter module (GM4/6)

Programmable Logic Controller

■ Features

- Pulse input support (5V, 12V, 24V)
- Counting range from -2,147,483,648 to 2,147,483,647
- Max. counting speed: 500kpps
- Coincidence output selection (Max. 4 points)
- Various multiplication (1/2/4-multiplication phase up/down counter)
- Phase input (A, B and Z phase)
- External preset input
(G4F-HO1A, G4F-HD1A, G6F-HO1A, G6F-HD1A, G6F-HSCA)
- Incremental encoder available to use
(Absolute encoder: Not available)



■ Specifications



Item	G4F-HSCA	New type		G6F-HSCA
		G4F-HO1C G6F-HO1C	G4F-HD1C G6F-HD1C	
Number of channel(s)	1	2		1
Counter	A, B, Z (phase)	A, B (phase)		A, B, Z (phase)
input		DC 5V, 12V, 24V		EIA RS-422A standard (DC5V)
signal		Voltage input		DC 5V, 12V, 24V
Counting range	0~16,777,215 (Binary 24bits)	-2,147,483,648~2,147,483,647 (Binary 32bits)		0~16,777,215 (Binary 24bits)
Counting speed	50kpps	200kpps	500kpps	50kpps
Up/down counter	1-phase input 2-phase input	Program or B phase Phase difference		
setting	CW/CCW	A-phase: Up count, B-phase: Down count		
Multiplication	1-phase input 2-phase input	1/2 multiplication (Program)	-	1/2 multiplication (Program)
External input	Preset Limit switch Gate	DC 5V, 12V, 24V		DC 24V DC 24V
External output	Type Signal	OUT1, OUT2 (Select: >, =, <)		OUT1, OUT2 (Select: >, =, <)
Additional functions		Tr. output DC 24V		Tr. output DC 24V, 200mA
Current consumption	250mA	270mA	330mA	180mA

GMWIN software

Programmable Logic Controller

■ Features

- Supports the international language (IEC61131-3)
 - IL, LD, SFC
- Supports Windows 95, 98, ME, NT, 2000, XP
- Simulation
 - Program test and debugging without PLC
- Editing, monitoring, debugging using symbol and variable name
- Automatic memory allocation support
 - Compiler sets a variable location automatically
- Optimization (PLC code) by compiler method
- User-defined function/function block support

■ Features

- Function (Type conversion, Arithmetic, Comparison, Array operation function)
- Function block (Timer, Counter, etc)

■ System requirement

- Intel compatible PC (Intel Pentium CPU or later)
- Windows 95, 98, ME, NT, 2000, XP
- Video adapter (VGA or later)
- Mouse/Printer compatible with Windows
- 128M RAM and 20M free hard disk space

■ Languages

- IL (Instruction list)
- LD (Ladder diagram)
- SFC (Sequential function chart)

■ Cable connection for PC: K1C-050A

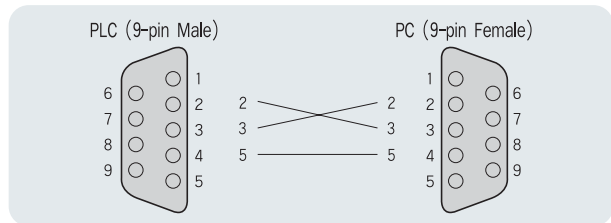

■ System configuration

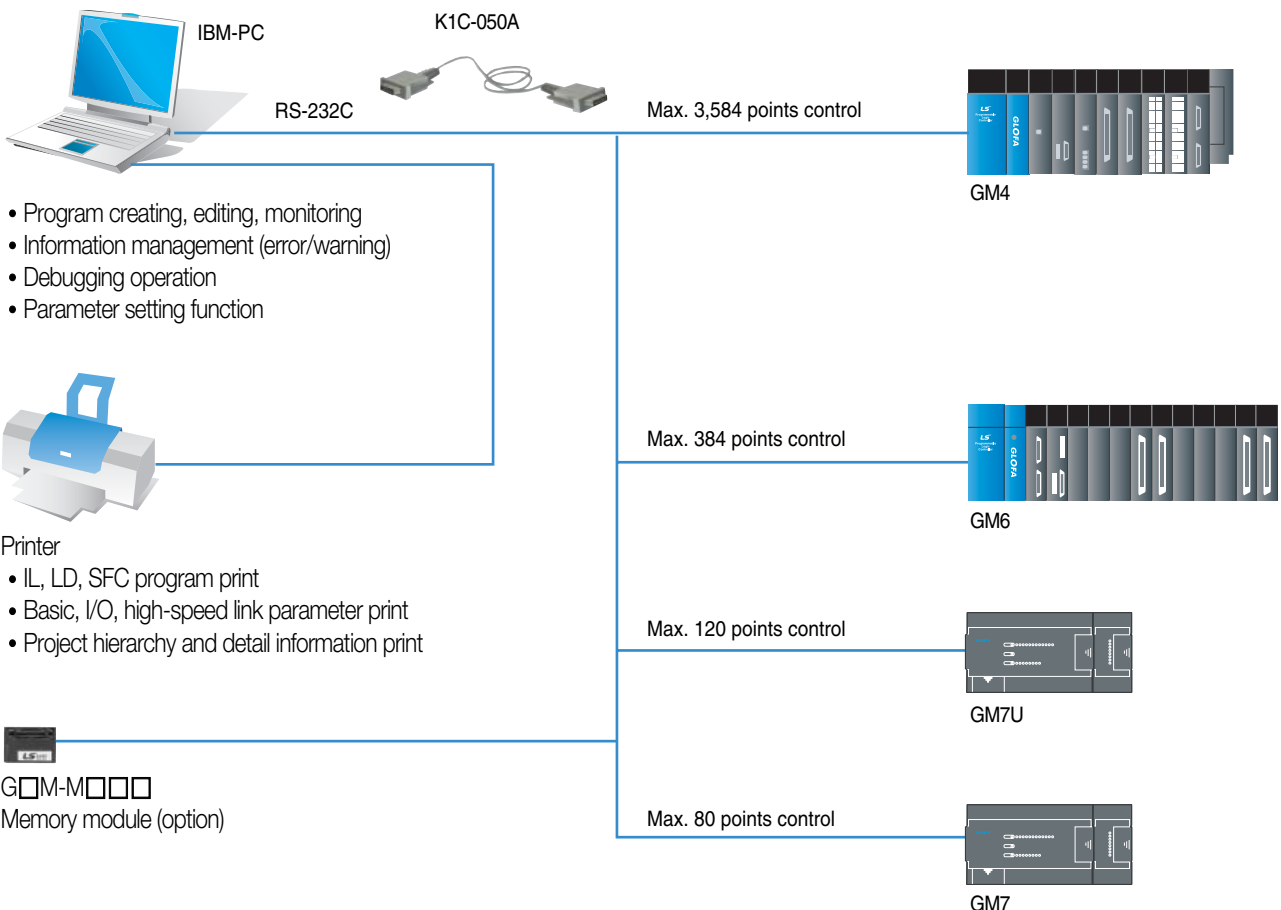

XGT Panel XP Series

Programmable Logic Controller

■ Features

- High and vivid distinction with 65,536 colors
- Various vector symbols and high quality raster symbols
- Support diverse file types including BMP, JPG, GIF, and WMF, etc
- Simple movie clip effects with GIF animation
- 10/100 BASE-T Ethernet interface
- Convenient and easy screen editing
- Strengthened data management (Logging, Recipe, and Alarm)
- Read function of a controller's state information (Monitoring and maintenance)
- Multi-lingual display up to 4 languages and easy switching
- Offline program simulation
- Tag function of the HMI S/W (Easy to change the address of the graphic objects)
- USB host for the use of peripheral devices (Mouse, keyboard, printer, etc)
- Sufficient memory space for screen saving (10MB)



■ Specifications

Item	XP30-BTE/DC	XP30-BTA/DC	XP30-TTA/DC	XP50-TTA/DC	XP70-TTA/AC XP70-TTA/DC	XP80-TTA/AC XP80-TTA/DC	XP90-TTA/AC	
	Mono			Color				
Display description	Mono Blue LCD			TFT Color LCD				
Display Size (inch)	14cm (5.7")			21cm (8.4")	26cm (10.4")	31cm (12.1")	38cm (15")	
Resolution	320×240			640×480		800×600	1024×768	
Color	8-bit Gray Scale			320×240				
Backlight	LED			CCFL (whole LCD), auto On/Off (50,000hr)				
Contrast	Adjustable			Fixed				
Luminance	230cd/m ²			400cd/m ²	480cd/m ²	430cd/m ²	400cd/m ²	450cd/m ²
Viewing angle	Up/Down(Degree)	20/40	20/40	70/50	60/50	65/45	75/45	60/50
	Left/Right(Degree)	45/45	45/45	70/70	65/65	65/65	65/65	75/75
Touch panel	4-wire system, analog			8-wire system, analog				
LED	Green: Run (Monitoring, download drawing data) Red: Error (Communication error, drawing data error)							
Processor	ARM920T(32bit RISC), 200MHz							
Memory	Display data	3MB	10MB				20MB	
	Backup data	128KB	512KB (Logging, alarm data saving)					
Ethernet	1ch, IEEE802.3, 10/100Base-T							
USB interface	USB Host×1	USB Host×2						
Serial	RS-232C	2ch (1 port for PC communication)						
	RS-422/485	1ch, 422/485						
CF memory card interface	-	CF memory card (TYPE-1)×1						
AUX interface	-	Optional						
Certification	CE, UL, KCC							
Protection	IP65F (Front Water Proof Structure)							
Size (W×H×D)mm	181×140×56.5	181×140×66.5		240×174×73	317×243×73		395×294×73	
Panel Cut (W×H)mm		155.5×123		228×158	294×227		383×282	
Weight (kg)	0.62	0.75		1.4	2.2	2.4	3.9	
Power	Rated voltage	DC 24V			AC100~220V, DC 24V		AC100~220V	
	Permitted voltage	AC	-			MIN 85 VAC, MAX 264 VAC		MIN 85 VAC,
		DC	MIN 19.2 VDC, MAX 28.8 VDC			MIN 19.2 VDC, MAX 28.8 VDC		MAX 264 VAC
	Watt	AC	-	-	-	37	40	46
DC		5	8.5		20	30		

XGT PANEL

Programmable Logic Controller

■ Features

Enhancing User-friendliness

- Flexible to draw: 192 X 64 Dot Graphic LCD
- Easy to upgrade: O/S and font download
- Various tag/drawing functions support: 15 types
- Easy to manage data: internal memory (1000 words) support
- User-defined function keys support for each screen (F1~F4, ◀, ▶, ▲, ▼)
- User-defined bitmap file input support
- Region-based upload/download support
- Built-in RTC: B type
- Large screen memory: 256K

Flexible to supply power

- 5V supply by loader port for LS PLC and INV connection
- DC 24V supply from DC 24V input terminal

Language support

- English, Chinese, Korean
- Font-download adoption support



Strong communication functions

- Separate 2Ch support: RS-232C and RS-422/485
- Multi master communication (N:M) support
 - Monitoring M PLCs with N XGT PANELs

Various communication modes and protocol driver supply

- LS PLC: loader and link (Cnet)
- LS VFD: loader (iS5/iP5(A)/iV5) and RS-485
- MODBUS ASCII/RTU protocol
- Mitsubishi FX series
- OMRON C-mode protocol
- Communication drivers are continually added and updated.

■ Performance Specifications

Item	Specifications		Remark
	XP10BKA/DC	XP10BKB/DC	
Input power	4.9~5.1VDC (RS-232C Connector), or 21.6V~26.4VDC (Power supply connector)		
Display	LED Back-light (192*64 Dot)		
Communication Interface	RS-232C, RS-422/485		Independent 2 channels
Memory	256k bytes		
Languages	English, Chinese, Korean		
RTC	None	Supports	
Up/Download spec.	Speed: 115,200bps Each memory area can be up/downloaded in part		
Key	12keys (F1~F4, ESC, ALM, ▲, ▼, ▶, ◀, SET, ENT)		
System memory	User area	M000~M899 (900 Word)	Latch area is supported, in XP 10BKB/DC
	System flags	M900~M999 (100 Word)	

■ Easy drawing tool: Panel editor

- Easy Programming
- Drawing Tool
- Direct Device Input
- Snap/Align Functions
- Print Function
- Simple Memory Management

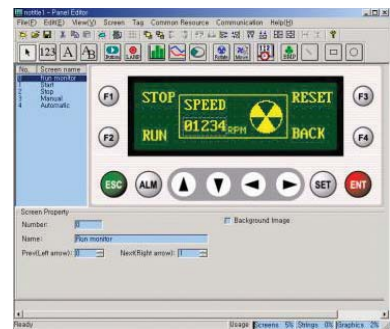

■ Cable connection for program downloading

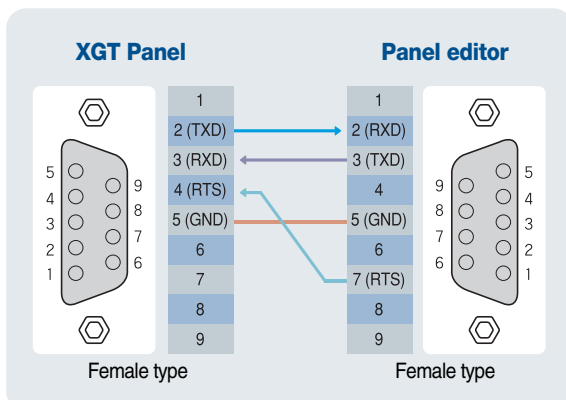

■ Dimensions

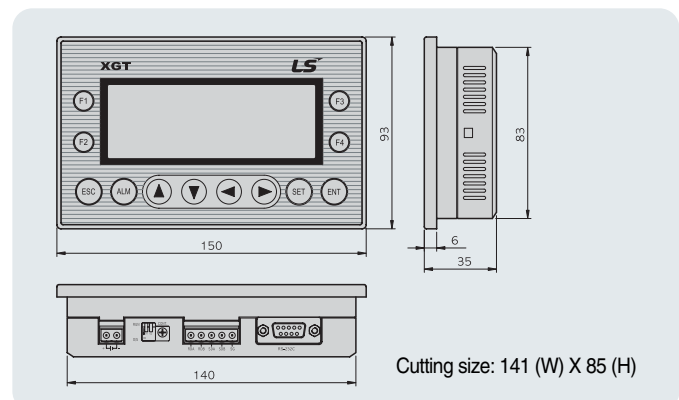

Command

Programmable Logic Controller

■ Sequence operation

Symbol	Description	Remark
	Normally open contact	
	Normally closed contact	
	Positive transition-sensing contact	
	Negative transition-sensing contact	
	Coil	
	Negative coil	
	Set (Latch) coil	
	Reset (Unlatch) coil	
	Positive transition-sensing coil	
	Negative transition-sensing coil	
	Jump to label	
	End subroutine program	
	Call subroutine	

■ Function

Instruction	Symbol	Description	Remark
MOVE		Data movement IN1: Value to be moved (ANY) OUT: Moved value (ANY)	
****_TO_****		Type conversion IN: Input OUT: Output Type conversion function SINT__TO__JNT plus 14 types INT__TO__SINT plus 14 types DINT__TO__SINT plus 14 types LINT__TO__SINT plus 14 types USINT__TO__SINT plus 14 types UINT__TO__SINT plus 15 types UDINT__TO__SINT plus 16 types ULINT__TO__SINT plus 14 types BOOL__TO__SINT plus 12 types BYTE__TO__SINT plus 13 types WORD__TO__SINT plus 13 types DWORD__TO__SINT plus 15 types LWORD__TO__SINT plus 14 types BCD__TO__SINT plus 8 types REAL__TO__SINT plus 9 types LREAL__TO__SINT plus 9 types STRING__TO__SINT plus 18 types NUM__TO__STRING TIME__TO__UDINT plus 2 types DATE__TO__UINT plus 2 types TOD__TO__UDINT plus 2 types DT__TO__DATE plus 3 types	LINT, ULINT LWORD, REAL, LREAL are available in GM4C *
TRUNC		Converting Real to Integer number IN: Input (REAL, LREAL) OUT: Output (DINT, LINT)	GM4C only
ADD		Addition IN1: Value to be added IN2~IN8: Value to add (ANY_NUM) OUT: Added value (ANY_NUM)	
SUB		Subtraction IN1: Value to be subtracted (ANY_NUM) IN2: Value to subtract (ANY_NUM)	
MUL		Multiplication IN1: Multiplicand IN2~IN8: Multiplier (ANY_NUM) OUT: Multiplied value (ANY_NUM)	
DIV		Division IN1: Dividend (ANY_NUM) IN2: Divisor (ANY_NUM) OUT: Quotient (ANY_NUM)	

* GM4C: GM4-CPUC

Command

Programmable Logic Controller

■ Function

Instruction	Symbol	Description	Remark
MOD		Divided result (Remainder) IN1: Dividend (ANY_INT) IN2: Divisor (ANY_INT) OUT: Remainder (ANY_INT)	
EXPT		Exponential operation IN1: Real number (ANY_REAL) IN2: Exponent (ANY_NUM) OUT: Result (ANY_REAL)	GM4C only
ABS		Absolute value operation IN: Input (ANY_NUM) OUT: Absolute value (ANY_NUM)	GM4C only
SQRT		Square root operation IN: Input value (ANY_REAL) OUT: Square root value (ANY_REAL)	GM4C only
LN		Natural logarithm operation IN: Input value (ANY_REAL) OUT: Natural logarithm value (ANY_REAL)	GM4C only
LOG		Base 10 logarithm operation IN: Input value (ANY_REAL) OUT: Base 10 logarithm value (ANY_REAL)	GM4C only
EXP		Natural exponential operation IN: Input value (ANY_REAL) OUT: Result (ANY_REAL)	GM4C only
SIN		Sine operation IN: Input value (ANY_REAL) OUT: Result (ANY_REAL)	GM4C only
COS		Cosine operation IN: Input value (ANY_REAL) OUT: Result (ANY_REAL)	GM4C only
TAN		Tangent operation IN: Input value (ANY_REAL) OUT: Result (ANY_REAL)	GM4C only
ASIN		Arc Sine operation IN: Input value (ANY_REAL) OUT: Result (ANY_REAL)	GM4C only
ACOS		Arc Cosine operation IN: Input value (ANY_REAL) OUT: Result (ANY_REAL)	GM4C only
ATAN		Arc Tangent operation IN: Input value (ANY_REAL) OUT: Result (ANY_REAL)	GM4C only
SHL		Shift left operation IN: Bit string (ANY_BIT) N: Bit number to be shifted (INT) OUT: Shifted value (ANY_BIT)	
SHR		Shift right operation IN: Bit string (ANY_BIT) N: Bit number to be shifted (INT) OUT: Shifted value (ANY_BIT)	
ROL		Rotate to left IN: Value to be rotated (ANY_BIT) N: Bit number to rotate (INT) OUT: Rotated value (ANY_BIT)	
ROR		Rotate to right IN: Value to be rotated (ANY_BIT) N: Bit number to rotate (INT) OUT: Rotated value (ANY_BIT)	

■ Function

Instruction	Symbol	Description	Remark
AND		Logical AND IN1~IN8: Input (ANY_BIT) OUT: AND Result (ANY_BIT)	
OR		Logical OR IN1, IN2: Input (ANY_BIT) OUT: OR Result (ANY_BIT)	
XOR		Exclusive OR IN1, IN2: Input (ANY_BIT) OUT: XOR Result (ANY_BIT)	
NOT		Logic inversion (NOT) IN: Input (ANY_BIT) OUT: NOT Result (ANY_BIT)	
SEL		Selection G: Selection IN0, IN1: Value to be selected (ANY) OUT: Selected value (ANY)	
MAX		Maximum value IN1: Value to be compared (ANY) IN2~IN8: Value to compare (ANY) OUT: Maximum value (ANY)	
MIN		Minimum value IN1: Value to be compared (ANY) IN2~IN8: Value to compare (ANY) OUT: Minimum value (ANY)	
LIMIT		Limit upper and lower boundary MN: Minimum value (ANY) IN: Value to be limited (ANY) MX: Maximum value (ANY) OUT: Value in the range (ANY)	
MUX		Multiplexer K: Selection (INT) IN0~IN6: Value to be selected (ANY) OUT: Selected value (ANY)	
GT (>)		'Greater than' comparison IN1: Value to be compared (ANY) IN2~IN8: Comparing value (ANY) OUT: Comparison result (BOOL) If IN1 > IN2 > ... IN7 > IN8, output is 1	
GE (≥)		'Greater than or equal to' comparison IN1: Value to be compared (ANY) IN2~IN8: Comparing value (ANY) OUT: Comparison result (BOOL) If IN1 ≥ IN2 ≥ ... IN7 ≥ IN8, output is 1	
EQ (=)		'Equal to' comparison IN1: Value to be compared (ANY) IN2~IN8: Comparing value (ANY) OUT: Comparison result (BOOL) If IN1 = IN2 = ... IN7 = IN8, output is 1	
LE (≤)		'Less than or equal to' comparison IN1: Value to be compared (ANY) IN2~IN8: Comparing value (ANY) OUT: Comparison result (BOOL) If IN1 ≤ IN2 ≤ ... IN7 ≤ IN8, output is 1	
LT (<)		'Less than' comparison IN1: Value to be compared (ANY) IN2~IN8: Comparing value (ANY) OUT: Comparison result (BOOL) If IN1 < IN2 < ... IN7 < IN8, output is 1	
NE (≠)		'Not equal to' comparison IN1, IN2: Comparing value (ANY) OUT: Comparing result (BOOL) If IN1 ≠ IN2, output is 1	

Command

Programmable Logic Controller

■ Function

Instruction	Symbol	Description	Remark
LEN		Character string length IN: Character string Input (STRING) OUT: Character string length (INT)	
LEFT		Left part of a character string IN: Input character string (STRING) L: Character string length to output (INT) OUT: Output character string (STRING)	
RIGHT		Right part of a character string IN: Input character string (STRING) L: Character string length to output (INT) OUT: Output character string (STRING)	
MID		Middle part of a character string IN: Input character string (STRING) L: Character string length to output (INT) P: String location of character string (INT) OUT: Output character string (STRING)	
CONCAT		Concatenation of a character string IN1~IN8: Input character string (STRING) OUT: Output character string (STRING)	
INSERT		Insertion of s character string IN1: Character string to be inserted (STRING) IN2: Character string to insert (STRING) P: Position to insert a character string (INT) OUT: Output character string (STRING)	
DELETE		Deletion of a character string IN: Input character string (STRING) L: Length of a character string to be deleted (INT) P: Position of a character string to delete (INT) OUT: Output character string (STRING)	
REPLACE		Character string Replacement IN1: Character string to be replaced (STRING) IN2: Character string to replace (STRING) L: Length of character string to be replaced (INT) P: Position of character string to be replaced (INT) OUT: Character string output (STRING)	
FIND		Find a character string IN1: Input character string (STRING) IN2: Character string to find (STRING) OUT: Location of character string to be found (INT)	
ADD_TIME		Time addition IN1: Reference time (TIME, TOD, TD) IN2: Time to add (TIME) OUT: Added result of TOD or time (TIME, TOD, TD)	
SUB_TIME		Time subtraction IN1: Reference time (TIME, TOD, TD) IN2: Time to subtract (TIME) OUT: Subtracted result of TOD or time (TIME, TOD, TD)	
SUB_DATE		Date and time subtraction IN1: Reference Date (DATE) IN2: Date to be subtracted (DATE) OUT: The difference between two dates as time (TIME)	
SUB_TOD		TOD subtraction IN1: Reference TOD (TIME_OF_DAY) IN2: TOD to subtract (TIME_OF_DAY) OUT: Subtracted result time (TIME)	



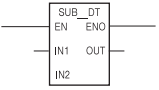
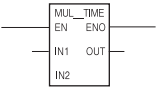
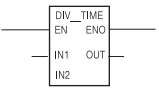
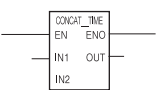
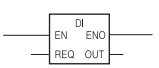
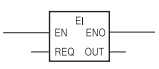
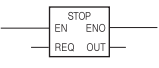
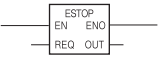
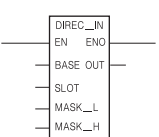
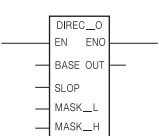
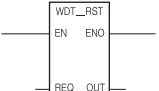
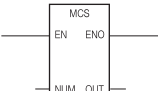
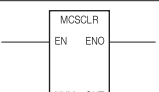

■ Function

Instruction	Symbol	Description	Remark
SUB_DT		Date and time subtraction N1: Reference DATE_AND_TIME (DATE_AND_TIME) IN2: DATE_AND_TIME to be Subtracted (DATE_AND_TIME) OUT: Subtracted result time (TIME)	
MUL_TIME		Time multiplication IN1: Time to be multiplied (TIME) IN2: Multiplying value (ANY_NUM) OUT: Multiplied result (TIME)	
DIV_TIME		Time division IN1: Time to divide (TIME) IN2: Value to divide (ANY_NUM) OUT: Divided result time (TIME)	
CONCAT_TIME		Character string concatenation IN1: Date input (DATE) IN2: TOD input (TOD) OUT: DT output	
DI		Not to permit task program operation REQ: Requires to invalidate task program (BOOL) OUT: If DI is executed, it will be 1 (BOOL)	
EI		To permit running for task program REQ: Requires to permit running task program (BOOL) OUT: If EI is executed, it will be 1 (BOOL)	
STOP		Stop by program REQ: STOP Request (BOOL) OUT: If STOP is executed, it will be 1 (BOOL)	
ESTOP		Emergency stop by program REQ: Emergency stop request (BOOL) OUT: If ESTOP is executed, it will be 1 (BOOL)	
DIREC_IN		Instant refreshment of input data BASE: Base number of input module (USINT) SLOT: Slot number of input module (USINT) MASK_L: Designating bits not to be refreshed among lower 32-bit data of input (DWORD) MASK_H: Designating bits not to be refreshed among upper 32-bit data of input (DWORD) OUT: If refreshment is completed, it will be 1 (BOOL)	
DIREC_O		Instant Refreshment of output data BASE: Base number of output module (USINT) SLOT: Slot number of output module (USINT) MASK_L: Designating bits not to be refreshed among lower 32-bit data of output (DWORD) MASK_H: Designating bits not to be refreshed among upper 32-bit data of output (DWORD) OUT: If refreshment is completed, it will be 1 (BOOL)	
WDT_RST		Watchdog timer reset REQ: Watchdog timer initialization request (BOOL) OUT: If WDT_RST is executed, it will be 1 (BOOL)	
MCS		Master control NUM: Nesting number (INT) OUT: Dummy (Always 0)	
MCSCLR		Master control clear NUM: Nesting number (INT) OUT: If MCSCLR is executed, it will be 1 (BOOL)	

Command

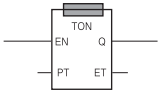
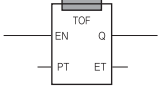
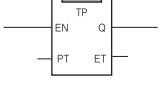
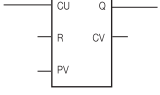
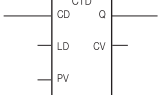
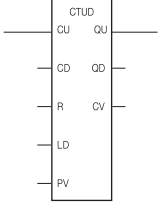
Programmable Logic Controller

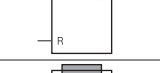
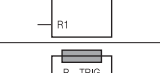
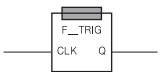
■ Function block

Instruction	Symbol	Description	Remark
TON		On delay timer EN: Timer operation condition (BOOL) PT: Preset time (TIME) Q: Timer output (BOOL) ET: Elapsed time (TIME)	
TOF		Off delay timer EN: Timer operation condition (BOOL) PT: Preset time (TIME) Q: Timer output (BOOL) ET: Elapsed time (TIME)	
TP		Pulse timer EN: Timer operation condition (BOOL) PT: Preset time (TIME) Q: Timer output (BOOL) ET: Elapsed time (TIME)	
CTU		Up counter CU: Up counter pulse input (BOOL) R: Reset input (BOOL) PV: Preset value (INT) Q: Up counter output (BOOL) CV: Current value (INT)	
CTD		Down counter CD: Down counter pulse input (BOOL) LD: Load preset value (BOOL) PV: Preset value (INT) Q: Down counter output (BOOL) CV: Current value (INT)	
CTUD		Up/Down counter CU: Up counter pulse input (BOOL) CD: Down counter pulse input (BOOL) R: Reset input (BOOL) LD: Load preset value (BOOL) PV: Preset value (INT) QU: Up counter output (BOOL) QD: Down counter output (BOOL) CV: Current value (INT)	
SEMA		Semaphore for system resource allocation CLAIM: Resource monopoly request signal (BOOL) RELEASE: Release signal (BOOL) BUSY: Waiting signal not to obtain the claimed resource (BOOL)	
SR		Set priority bistable S1: Set condition (BOOL) R: Reset condition (BOOL) Q1: Operation result (BOOL)	
RS		Reset priority bistable S: Set condition (BOOL) R1: Reset condition (BOOL) Q1: Operation result (BOOL)	
R_TRIG		Rising edge detection CLK: Input clock (BOOL) Q: Rising edge detection result (BOOL)	
F_TRIG		Falling edge detection CLK: Input signal (BOOL) Q: Falling edge detection result (BOOL)	
RTC_SET		RTC data setting REQ: Request (BOOL) DATA: Time data to input (ARRAY) DONE: Without an error, it will be 1 (BOOL) STAT: If an error occurs, an error code appears (USINT)	

Product list

Programmable Logic Controller

■ GM7/GM7U

Type	Part Number	Specification	Power supply	Remarks	
GM7 main	G7M-DR10A (/DC)	DC 24V Input 6 points, Relay output 4 points	AC 100~240V (DC 24V)		
	G7M-DR20A (/DC)	DC 24V Input 12 points, Relay output 8 points			
	G7M-DR30A (/DC)	DC 24V Input 18 points, Relay output 12 points			
	G7M-DR40A (/DC)	DC 24V Input 24 points, Relay output 16 points			
	G7M-DR60A (/DC)	DC 24V Input 36 points, Relay output 24 points			
	G7M-DT10A	DC 24V Input 6 points, Tr. output 4 points	AC 100~ 240V		
	G7M-DT20A	DC 24V Input 12 points, Tr. output 8 points			
	G7M-DT30A	DC 24V Input 18 points, Tr. output 12 points			
	G7M-DT40A	DC 24V Input 24 points, Tr. output 16 points			
	G7M-DT60A	DC 24V Input 36 points, Tr. output 24 points			
GM7U main	G7M-DR20U (/DC)	DC 24V Input 12 points, Relay output 8 points	AC 100~ 240V (DC 24V)		
	G7M-DR30U (/DC)	DC 24V Input 18 points, Relay output 12 points			
	G7M-DR40U (/DC)	DC 24V Input 24 points, Relay output 16 points			
	G7M-DR60U (/DC)	DC 24V Input 36 points, Relay output 24 points			
	G7M-DRT20U (/DC)	DC 24V Input 12 points, Tr. output 4 points/Relay output 4 points			
	G7M-DRT30U (/DC)	DC 24V Input 18 points, Tr. output 4 points/Relay output 8 points			
	G7M-DRT40U (/DC)	DC 24V Input 24 points, Tr. output 4 points/Relay output 12 points			
	G7M-DRT60U (/DC)	DC 24V Input 36 points, Tr. output 4 points/Relay output 20 points			
	G7M-DT20U (N) (/DC)	DC 24V Input 12 points, NPN Tr. output 8 points			
	G7M-DT30U (N) (/DC)	DC 24V Input 18 points, NPN Tr. output 12 points			
	G7M-DT40U (N) (/DC)	DC 24V Input 24 points, NPN Tr. output 16 points			
	G7M-DT60U (N) (/DC)	DC 24V Input 36 points, NPN Tr. output 24 points			
	G7M-DT20U (P) (/DC)	DC 24V Input 12 points, PNP Tr. output 8 points			
	G7M-DT30U (P) (/DC)	DC 24V Input 18 points, PNP Tr. output 12 points			
	G7M-DT40U (P) (/DC)	DC 24V Input 24 points, PNP Tr. output 16 points			
	G7M-DT60U (P) (/DC)	DC 24V Input 36 points, PNP Tr. output 24 points			
Expansion module	Digital I/O	G7E-DR08A	From main module	GM7	
		G7E-DR10A			
		G7E-DR20A			
	Input	G7E-DC08A			
		Output		G7E-RY08A	
				G7E-RY16A	
G7E-TR10A	Tr. output 10 points				
Special module	Analog I/O	G7F-ADHA	DC 24V from external power supply	GM7	
		G7F-ADHB			
		G7F-ADHC			
	Analog Input	G7F-AD2A			
		G7F-AD2B		GM7	
	Analog Output	G7F-DA2I			
		G7F-DA2V			
	RTD Input	G7F-RD2A			
Analog Timer	G7F-AT2A	GM7			
Comm. module	Cnet I/F	G7L-CUEB	From main module		
		G7L-CUEC			
	Fnet I/F	G7L-FUEA			
	Rnet I/F	G7L-RUEA			
	Pnet I/F	G7L-PBEA			
Dnet I/F	G7L-DBEA				
Option	RTC pack	G7E-RTCA			
	Memory pack	G7M-M256		GM7 only	
		G7M-M256B		GM7U only	

* If a part number ends with /DC, the supply power is DC24V.

* Slim type: G7E-DC08A, G7E-DR08A, G7E-RY8A, G7F-ADHB, G7F-AD2B, G7F-RD2A

Product list

Programmable Logic Controller

GM6

Type	Part Number	Specification	Remarks	
CPU	GM6-CPUA	Max. I/O: 384 points, Program memory: 68K, Built-in function: RS-232		
	GM6-CPUB	Max. I/O: 384 points, Program memory: 68K, Built-in function: RS-422, PID, RTC		
	GM6-CPUC	Max. I/O: 384 points, Program memory: 68K, Built-in function: RS-232C, PID, RTC, HSC (50kpps)		
Power module	GM6-PAFA	AC input (Free), output: DC 5V 2A, DC 24V 0.3A		
	GM6-PAFB	AC input (Free), output: DC 5V 2A, DC 15V 0.5A, DC -15V 0.2A, when analog module used	Analog	
	GM6-PAFC	AC input (Free), output: DC 5V 3.5A, DC 24V 0.3A for 12-slot base board		
	GM6-PA2A	AC 220V Only, output: DC 5V 6A		
	GM6-PDFA	DC 12/24V input, output: DC 5V 2A		
	GM6-PDFB	DC 12/24V input, output: DC 5V 3A, DC 15V 0.5A, DC -15V 0.2A, when analog module used	Analog	
	Base	GM6-B04M	4-slot base board	
GM6-B06M		6-slot base board	Not expandible	
GM6-B08M		8-slot base board		
GM6-B12M		12-slot base board, Comm I/F module installation: slot 0~7		
DC input module	G6I-D21A	DC 12/24V input 8 points, Current Sink/Source type		
	G6I-D22A	DC 12/24V input 16 points, Current Sink/Source type		
	G6I-D22B	DC 24V input 16 points, Current Source type		
	G6I-D24A	DC 12/24V input 32 points, Current Sink/Source type		
	G6I-D24B	DC 24V input 32 points, Current Source type		
AC input module	G6I-A11A	AC 110V input 8 points		
	G6I-A21A	AC 220V input 8 points		
Relay output module	G6Q-RY1A	Relay output 8 points, DC 12/24V, AC 220V, 2A		
	G6Q-RY2A	Relay output 16 points, DC 12/24V, AC 220V, 2A	AC, DC	
	G6Q-RY2B	Relay output 16 points, DC 12/24V, AC 220V, 2A, Surge absorber		
Transistor output module	G6Q-TR2A	Tr. (NPN) output 16 points, DC 12/24V, 0.5A		
	G6Q-TR2B	Tr. (PNP) output 16 points, DC 12/24V, 0.5A		
	G6Q-TR4A	Tr. (NPN) output 32 points, DC 12/24V, 0.1A	DC	
	G6Q-TR4B	Tr. (PNP) output 32 points, DC 12/24V, 0.1A		
Triac output module	G6Q-SS1A	DC 12/24V input 8 points, AC 100~240V, 0.6A	AC	
I/O hybrid module	G6H-DR2A	DC 12/24V input 8 points, Relay output 8 points		
Special module	A/D module	G6F-AD2A	V/I input: 4 CHs, DC 1~5V, 0~10V, -10~10V, 4~20mA	
	D/A module	G6F-DA2V	V output: 4 CHs, DC -10~10V	GM6-PAFB/PDFB
		G6F-DA2I	I output: 4 CHs, DC 4~20mA	
	HSC module	G6F-HSCA	1Ch, Counting range: 0~16,777,215	
		G6F-HD1C	2 CHs, 500kpps, Counting range: -2,147,483,648~2,147,483,647, Line drive type	
		G6F-HO1C	2 CHs, 200kpps, Counting range: -2,147,483,648~2,147,483,647, Open collector type	
	Positioning module	G6F-PPxO	X=1, 2, 3: axis, Pulse output, 200kpps, Open collector type	
G6F-PPxD		X=1, 2, 3: axis, Pulse output, 1M, Line drive type	CPU V2.0 ↑	
Thermocouple input module	G6F-TC2A	Input: 4 CHs (Thermocouple: K, J, E, T, B, R, S)	GM6-PAFB/PDFB	
Comm. module	Fast Enet I/F module (Open type)	G6L-EUTB	10/100BASE-TX, UTP	
		G6L-EUFB	100BASE-FX, Fiber optic	
	Fast Enet I/F module (Dedicated Master)	G6L-EUTC	10/100BASE-TX, UTP	
		G6L-EUFC	100BASE-FX, Fiber optic	CPU V2.1 ↑
	Fast Enet I/F module (Dedicated Slave)	G6L-ERTC	10/100BASE-TX, UTP	
		G6L-ERFC	100BASE-FX, Fiber optic	
	Fnet I/F module	G6L-FUEA	Fnet master module (Shielded twisted pair cable, 1Mbps)	
	Fnet remote I/F module	G6L-RBEA	Fnet remote module (Shielded twisted pair cable, 1Mbps)	
	Dnet I/F module	G6L-DUEA	DeviceNet master module (500kpbs MAX.)	
	Pnet I/F module	G6L-PU EA	Profibus-DP master module (1K)	
		G6L-PU EB	Profibus-DP master module (7K)	
	Rnet I/F module	G6L-RUEA	Rnet master module	
	Cnet I/F module	G6L-CUEB	RS-232C	
		G6L-CUEC	RS-422/485	
Dummy module	GM6-DMMA	Dummy module for empty I/O slot		

■ GM4

Type	Part Number	Specification	Remarks
CPU	GM4-CPUA	Max. I/O: 2,048 points, Program memory: 128K, Data memory: 52K	
	GM4-CPUB	Max. I/O: 2,048 points, Program memory: 128K, Data memory: 50K	
	GM4-CPUC	Max. I/O: 2,048 points, Program memory: 1M, Data memory: 428K	
Main base	GM4-B04M	4-slot main base board	
	GM4-B06M	6-slot main base board	
	GM4-B08M	8-slot main base board	
	GM4-B12M	12-slot main base board (Slot no. 8 is treated as slot no. 0 of base no. 1)	Not expandable
Main base * (High functional)	GM4-B4MH	4-slot main base board (High functional)	
	GM4-B6MH	6-slot main base board (High functional)	
	GM4-B8MH	8-slot main base board (High functional)	
Expansion base	GM4-B04E	4-slot expansion base board	
	GM4-B06E	6-slot expansion base board	
	GM4-B08E	8-slot expansion base board	
Expansion base * (High functional)	GM4-B4EH	4-slot Expansion base board (High functional)	
	GM4-B6EH	6-slot Expansion base board (High functional)	
	GM4-B8EH	8-slot Expansion base board (High functional)	
Expansion cable	G4C-E041	Length: 0.4m	
	G4C-E121	Length: 1.2m	
	G4C-E301	Length: 3.0m	
Expansion cable * (High functional)	G4C-E061	Length: 0.6m	
	G4C-E601	Length: 6m	
	G4C-E102	Length: 10m	
Power module	G4C-E152	Length: 15m	
	GM4-PA1A	AC 110V input, DC 5V: 4A, DC 24V: 0.7A	
	GM4-PA2A	AC 220V input, DC 5V: 4A, DC 24V: 0.7A	
	GM4-PA2C	AC 220V input, DC 5V: 8A	
DC input module	GM4-PD3A	DC 24V input, DC 5V: 4A	
	G4I-D22A	16 points DC 12/24V input (Current Sink/Source type)	
	G4I-D22B	16 points DC 12/24V input (Current Source type)	
	G4I-D22C	16 points DC 24V input (Current Sink/Source type)	
	G4I-D24A	32 points DC 12/24 input (Current Sink/Source type)	
	G4I-D24B	32 points DC 12/24 input (Current Source type)	
	G4I-D24C	32 points DC 24 input (Current Sink/Source type)	
AC input module	G4I-D28A	64 points DC 12/24 input (Current Sink/Source type)	
	G4I-A12A	16 points AC 110V input	
Relay output module	G4I-A22A	16 points AC 220V input	
	G4Q-RY2A	16 points Relay output (2A)	AC, DC
Transistor output module	G4Q-TR2A	16 points Tr. (NPN) output (0.5A) (Sink type)	DC
	G4Q-TR2B	16 points Tr. (PNP) output (0.5A) (Source type)	
	G4Q-TR4A	32 points Tr. (NPN) output (0.1A) (Sink type)	
	G4Q-TR4B	32 points Tr. (PNP) output (0.1A) (Source type)	
	G4Q-TR8A	64 points Tr. (NPN) output (0.1A) (Sink type)	
Triac output module	G4Q-SS2A	16 points Triac output (1.0A)	AC
	G4Q-SS2B	16 points Triac output (0.6A)	
I/O hybrid module	G4H-DR2A	8 points DC 12/24V input, 8 points relay output	
	G4H-DT2A	8 points DC 12/24V input, 8 points Tr. output	
A/D module	G4F-AD2A	V/I input: 4 CHs (DC -5~-5V/-10~-10V/DC -20~-20mA)	
	G4F-AD3A	V/I input: 8 CHs (DC 1~-5V/0~-10V/DC 4~-20mA)	
D/A module	G4F-DA1A	V/I output: 2 CHs (DC -10~-10V, DC 4~-20mA)	
	G4F-DA3V	V output: 8 CHs (DC -10~-10V)	
	G4F-DA3I	I output: 8 CHs (DC 4~-20mA)	
	G4F-DA2V	V output: 4 CHs (DC-10~-10V)	
	G4F-DA2I	I output: 4 CHs (4~-20mA)	
HSC module	G4F-HSCA	1 CH, 50kHz, Counting range: 0~16,777,215	
	G6F-HO1C	2 CHs, 200kpps, Counting range: -2,147,483,648~+2,147,483,647, Open collector type	
	G6F-HD1C	2 CHs, 500kpps, Counting range: -2,147,483,648~+2,147,483,647, Line drive type	
Positioning module	G4F-PPxO	X=1, 2, 3: axis, Pulse output, 200kpps, Open Collector Type	CPU V2.6 ↑
	G4F-PPxD	X=1, 2, 3: axis, Pulse output, 1Mbps, Line Drive Type	
Thermocouple input module	G4F-TC2A	Input: 4 CHs (Thermocouple: K, J, E, T, B, R, S)	
Temperature control module	G4F-TMCA	Temp. control (AI/AO=2/2 CHs) PID 2 loops, 2-point digital output	
RTD input	G4F-RD2A	Input: 4 CHs	
PID control module	G4F-PIDB	Max. 16-loop control (Autotuning), 16-point digital output	
Analog timer module	G4F-AT3A	Input: 8 points	Make to order
Interrupt module	G4F-INTA	Input: 8 CHs	
Memory module	GM4-M032	128kbyte (32kstep)	

Product list

Programmable Logic Controller

■ GM4

Type	Part Number	Specification	Remarks	
Comm. module	Fast Enet I/F module (Open type)	G4L-EUTB G4L-EUFB G4L-EU5B	10/100BASE-TX, UTP 100BASE-FX, Fiber optic 10BASE-5, AUI	CPU V2.7 ↑
	Fast Enet I/F Module (Dedicated Master)	G4L-EUTC G4L-EUFC G4L-EU5C	10/100BASE-TX, UTP 100BASE-FX, Fiber optic 10BASE-5, AUI	
	Fast Enet I/F module (Dedicated Slave)	G4L-ERTC G4L-ERFC G4L-ER5C	10/100BASE-TX, UTP 100BASE-FX, Fiber optic 10BASE-5, AUI	
	Fnet I/F module	G4L-FUEA	Fnet master module (Shielded twisted pair cable), 1Mbps	
		G4L-FUOA	Fnet master module (Optic cable)	
	Fnet remote I/F module	G4L-RBEA	Fnet remote module (Shielded twisted pair cable), 1Mbps	
	Dnet I/F module	G4L-DUEA	DeviceNet master module (500kbps MAX.)	
	Pnet I/F module	G4L-PUEA	Profibus-DP master module (1Kbyte)	
		G4L-PUEB	Profibus-DP master module (7Kbyte)	
		G4L-PUEC	Profibus-DP master module (7Kbyte)	
	Rnet I/F module	G4L-RUEA	Rnet master module	
	Cnet I/F module	G4L-CUEA	RS-232C/RS-422: 1Ch each, Stand alone/Interlocking mode	
	Dummy module	GM4-DMMA	Dummy module for empty I/O slot	
	Memory module	G4M-M032	Capacity: 128K (32k steps)	
	USB cable	USB-301A	Downloading cable for USB port of GM4-CPUC	GM4-CPUC

* In GM4-CPUC, you are supposed to use high-functional base (main/expansion) and high functional cable when you want to make more than 3-stage expansion.

Dimensions

Programmable Logic Controller

GM7/GM7U

Main

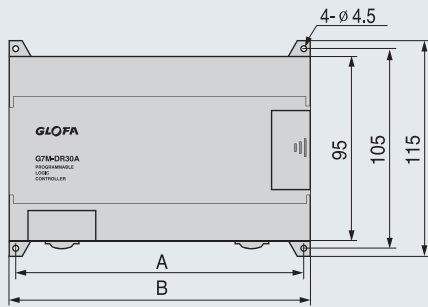

Expansion module

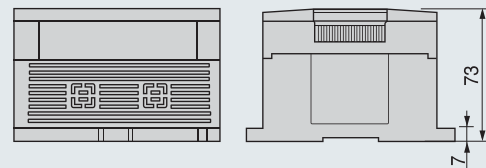
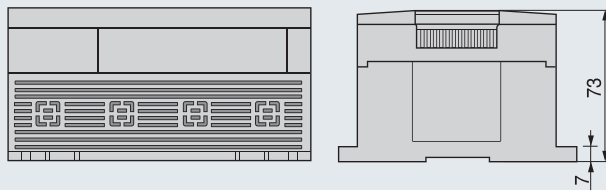
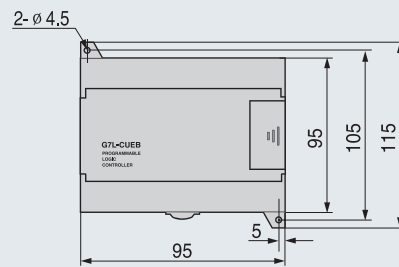

Expansion module (GM7U slim type)

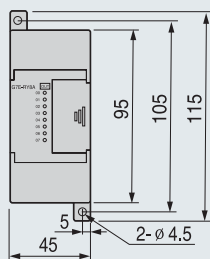

GM7	GM7U	A	B
G7M-D□10A		85	95
G7M-D□20A	G7M-D□20U	135	145
G7M-D□30A	G7M-D□30U	135	145
G7M-D□40A	G7M-D□40U	165	175
G7M-D□60A	G7M-D□60U	215	225

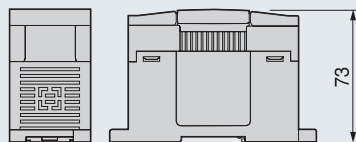

Dimensions

Programmable Logic Controller

GM6

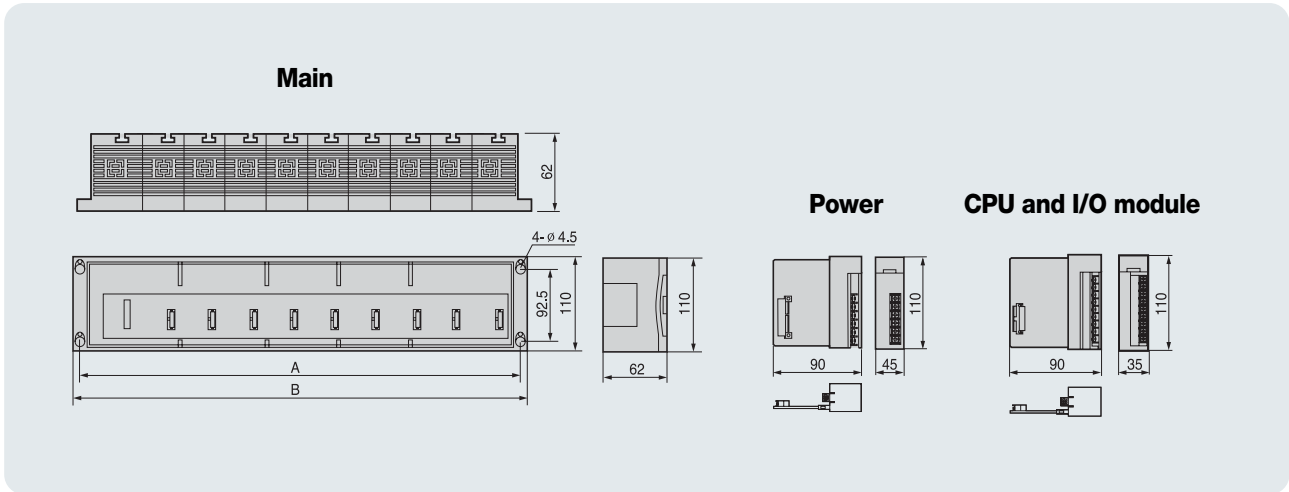

Width of base

(Unit: mm)

	Base board			
	GM6-B04M	GM6-B06M	GM6-B08M	GM6-B12M
A	230.5	300.5	370.5	510.5
B	244	314	384	524

GM4

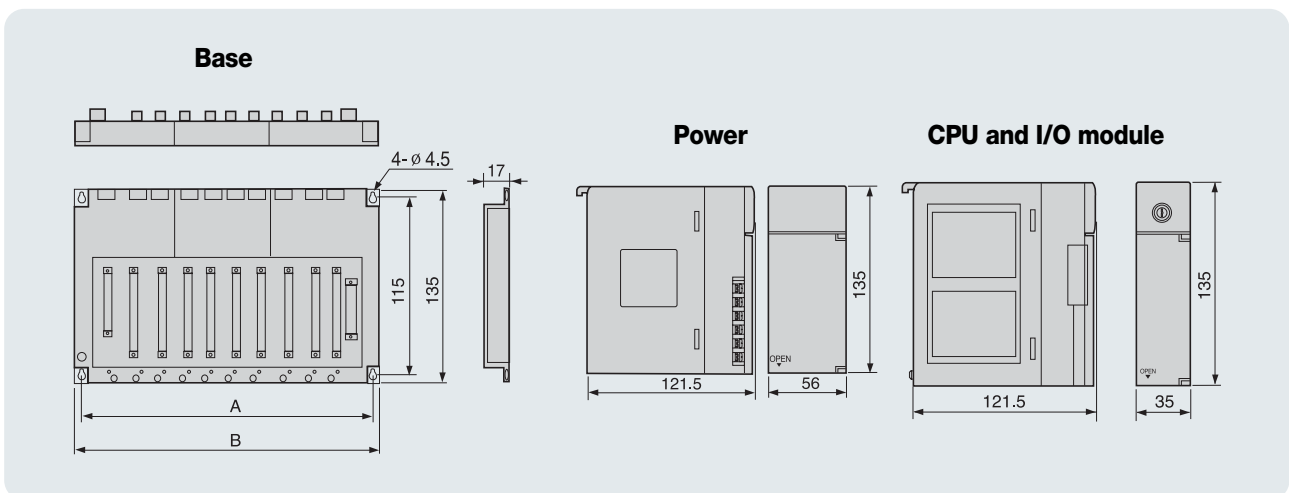

Width of base

(Unit: mm)

	Base board				Expansion Base		
	GM4-B04M	GM4-B06M	GM4-B08M	GM4-B12M	GM4-B04E	GM4-B06E	GM4-B08E
	GM4-B4MH	GM4-B6MH	GM4-B8MH		GM4-B4EH	GM4-B6EH	GM4-B8EH
A	284	354	424	524	284	354	424
B	297	367	440	540	297	367	437

Cable connection

Programmable Logic Controller

■ Cable connection

Loader cable: K1C-050A

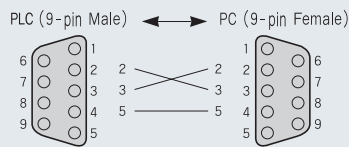

GM6 (A/C), GM7/GM7U loader and built-in Cnet

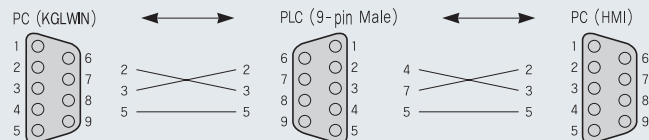

Rnet cable I (SMART I/O 5pin)

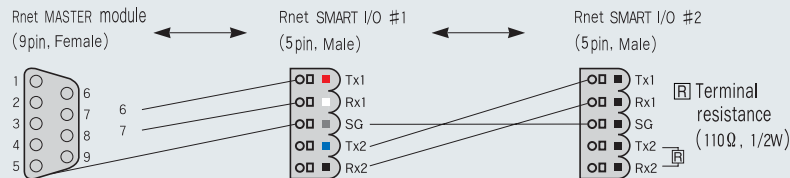

Rnet cable II (SMART I/O 9pin)

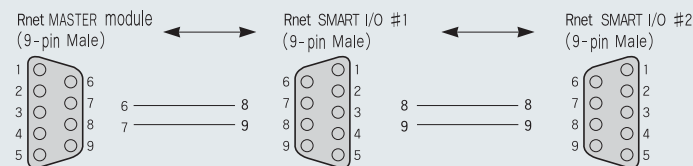

Modbus (RS-422)

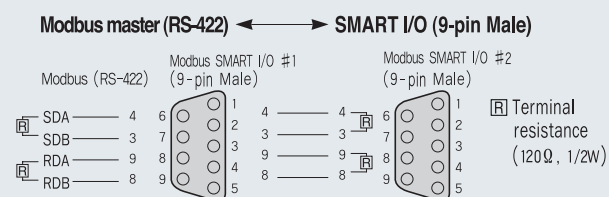



Safety Instructions

- For your safety, please read user's manual thoroughly before operating.
- Contact the nearest authorized service facility for examination, repair, or adjustment.
- Please contact qualified service technician when you need maintenance. Do not disassemble or repair by yourself!
- Any maintenance and inspection shall be performed by the personnel having expertise concerned.

© 2004.8 LS Industrial Systems Co.,Ltd. All rights reserved.

LS Industrial Systems Co., Ltd.

www.lsis.biz

■ **HEAD OFFICE**

LS Tower 1026-6, Hogue-dong, Dongan-gu, Anyang-si,
Gyeonggi-do 431-848, Korea

- **Europe** +82-2-2034-4376 / ywsohn@lsis.biz
- **Middle East** +82-2-2034-4901 / bonseongk@lsis.biz
- **South West Asia** +82-2-2034-4645 / sungkyup@lsis.biz
- **South East Asia** +82-2-2034-4707 / ohpark@lsis.biz
- **CIS** +82-2-2034-4913 / jinhkang@lsis.biz
- **America** +82-2-2034-4377 / younsupl@lsis.biz

■ **Global Network**

- **LS Industrial Systems (Middle East) FZE >> Dubai, U.A.E.**
Address: LOB 19 JAFZA VIEW TOWER Room 205, Jebel Ali Freezone P.O. Box 114216, Dubai, United Arab Emirates
Tel: 971-4-886 5360 Fax: 971-4-886-5361 e-mail: hwyim@lsis.biz
- **Dalian LS Industrial Systems Co., Ltd. >> Dalian, China**
Address: No.15, Liaohezi 3-Road, Economic and Technical Development zone, Dalian 116600, China
Tel: 86-510-8534-6666 Fax: 86-510-522-4078 e-mail: xuhg@lsis.com.cn
- **LS Industrial Systems (Wuxi) Co., Ltd. >> Wuxi, China**
Address: 102-A, National High & New Tech Industrial Development Area, Wuxi, Jiangsu, 214028, P.R.China
Tel: 86-510-8534-6666 Fax: 86-510-522-4078 e-mail: xuhg@lsis.com.cn
- **LS-VINA Industrial Systems Co., Ltd. >> Hanoi, Vietnam**
Address: Nguyen Khe - Dong Anh - Ha Noi - Viet Nam
Tel: 84-4-882-0222 Fax: 84-4-882-0220 e-mail: srjo@lsisvina.com
- **LS-VINA Industrial Systems Co., Ltd. >> Hochiminh, Vietnam**
Address: 41 Nguyen Thi Minh Khai Str. Yoco Bldg 4th Floor, Hochiminh City, Vietnam
Tel: 84-8-3822-7941 Fax: 84-8-3822-7942 e-mail: sbpark@lsisvina.com
- **LS Industrial Systems Tokyo Office >> Tokyo, Japan**
Address: 16FL, Higashi-Kan, Akasaka Twin Tower 17-22, 2-chome, Akasaka, Minato-ku Tokyo 107-8470, Japan
Tel: 81-3-3582-9128 Fax: 81-3-3582-2667 e-mail: jschuna@lsis.biz
- **LS Industrial Systems Shanghai Office >> Shanghai, China**
Address: Room E-G, 12th Floor Huamin Empire Plaza, No.726, West Yan'an Road Shanghai 200050, P.R. China
Tel: 86-21-5237-9977 (609) Fax: 89-21-5237-7191 e-mail: jinhk@lsis.com.cn
- **LS Industrial Systems Beijing Office >> Beijing, China**
Address: B-Tower 17FL, Beijing Global Trade Center B/D, No.36, BeiSanHuanDong-Lu, DongCheng-District, Beijing 100013, P.R. China
Tel: 86-10-5825-6025,7 Fax: 86-10-5825-6026 e-mail: cuixiaorong@lsis.com.cn
- **LS Industrial Systems Guangzhou Office >> Guangzhou, China**
Address: Room 1403,14F, New Poly Tower, 2 Zhongshan Liu Road, Guangzhou, P.R. China
Tel: 86-20-8326-6764 Fax: 86-20-8326-6287 e-mail: linsz@lsis.biz
- **LS Industrial Systems Chengdu Office >> Chengdu, China**
Address: Room 1701 17Floor, huanminhanjun international Building, No1 Fuxing Road Chengdu, 610041, P.R. China
Tel: 86-28-8670-3101 Fax: 86-28-8670-3203 e-mail: yangcf@lsis.com.cn
- **LS Industrial Systems Qingdao Office >> Qingdao, China**
Address: 7B40, Haixin Guangchang Shenye Building B, No.9, Shandong Road Qingdao 26600, P.R. China
Tel: 86-532-8501-6568 Fax: 86-532-583-3793 e-mail: lij@lsis.com.cn



Specifications in this catalog are subject to change without notice due to continuous product development and improvement.